



ÇAĞRI[®]
ENDÜSTRİ A.Ş.

ALHAN[®]

KONVEYÖR PARÇALARI ve MODULAR HASIR BANTLAR
CONVEYOR COMPENENTS & MODULAR PLASTIC BELTS



MADE IN TURKEY

Üretimden Satış
From Production to Sales

2018

Tanıtıcı Belge (Broşür)

www.alhan-cagri.com



444 00 42

SERTİFİKA * CERTIFICATE * ZERTİFİKAT * СЕРТИФИКАТ



KALİTE YÖNETİMİ
QUALITY MANAGEMENT

ÇAĞRI ENDÜSTRİ MALLARI PAZARLAMA YATIRIM
SANAYİ VE TİCARET A.Ş.

kuruluşum,
company,

Davutpaşa Cad. No: 14 Kat: 2 Topkapı / İstanbul / Türkiye
adresinde,
at address,

KONVEYÖR PARÇALARI, MÜHENDİSLİK PLASTİKLERİ VE MAKİNE
ELEMANLARI TASARIM, ÜRETİM, SATIŞI DESIGN, PRODUCTION AND
SALES OF CONVEYOR PARTS, MACHINE ELEMENTS AND ENGINEERING
PLASTICS

kalite yönetim sistemi yürürlüğe koyduğu,
perform the quality management system,

ISO 9001:2015

standart taleplerinin yerine getirdiği belirlenmiştir.
the complete of the standard was determined,

İlk Yayın Tarihi / Date First Registered : 02.03.2010
Yayın Tarihi / Date Certificate Issued : 23.02.2018
Geçerlilik Periyodu / Period of Registration : 3 Yıl / Years
Geçerlilik Tarihi / Date Certificate Expires : 22.02.2019
Sertifika Numarası / Certificate No : 01/10077/09

Onay: 
Approver:



ASB Uluslararası Belgelendirme Gözetim ve Eğitim Hiz. Ltd. Şti. / ASB International Certification Surveillance, Auditing and Training Services Ltd. Company
Tatlısu Mh. Akıl İnan Sok. Servis Residence No:16 Daire:13 Kat:06 Ümraniye-İstanbul / TÜRKİYE. Tel: +90 216 526 10 04 Fax: +90 216 526 30 91 e-mail: info@asbcert.com
- Bu sertifika, kadar ki ASB'nin alanına yerli olarak geçerlidir. Sertifikanın durumu: www.asbort.com.tr adresinden kontrol edilebilir.
The Validity shall remain in force as long as the corporation follows instructions of ASB. Certificates status can be checked at www.asbort.com.tr



MARKA TESCİL BELGESİ

Marka No: 2012 15474
Eski No: Yoktur

Marka Sahibi: ÇAĞRI ENDÜSTRİ MALLARI PAZARLAMA YATIRIM SANAYİ VE TİCARET ANONİM ŞİRKETİ
YATIRIMCI VE İHRAÇÇISI

Adres: Davutpaşa Cad. No:14 Kat:2 ÜMRANİYE İLİ İSTANBUL

Marka Sınıfı: 25, 26, 35, 36, 37, 38, 39, 40, 41, 42, 43, 44, 45, 46, 47, 48, 49, 50, 51, 52, 53, 54, 55, 56, 57, 58, 59, 60, 61, 62, 63, 64, 65, 66, 67, 68, 69, 70, 71, 72, 73, 74, 75, 76, 77, 78, 79, 80, 81, 82, 83, 84, 85, 86, 87, 88, 89, 90, 91, 92, 93, 94, 95, 96, 97, 98, 99, 100

Markanın Korunması Hakkında 506 Sayılı Kanun Hükmünde Kararnameyle 30.03.2008 Tarihinde Bkazanılan CN V.ii. maddesi ile korunan markadır.

Marka tescil belgesi
Brand registration certificate



MARKA TESCİL BELGESİ

Marka No: 2012 15474
Eski No: Yoktur

Marka Sahibi: ÇAĞRI ENDÜSTRİ MALLARI PAZARLAMA YATIRIM SANAYİ VE TİCARET ANONİM ŞİRKETİ
YATIRIMCI VE İHRAÇÇISI

Adres: Davutpaşa Cad. No:14 Kat:2 ÜMRANİYE İLİ İSTANBUL

Marka Sınıfı: 25, 26, 35, 36, 37, 38, 39, 40, 41, 42, 43, 44, 45, 46, 47, 48, 49, 50, 51, 52, 53, 54, 55, 56, 57, 58, 59, 60, 61, 62, 63, 64, 65, 66, 67, 68, 69, 70, 71, 72, 73, 74, 75, 76, 77, 78, 79, 80, 81, 82, 83, 84, 85, 86, 87, 88, 89, 90, 91, 92, 93, 94, 95, 96, 97, 98, 99, 100

Markanın Korunması Hakkında 506 Sayılı Kanun Hükmünde Kararnameyle 30.03.2008 Tarihinde Bkazanılan CN V.ii. maddesi ile korunan markadır.

Endüstriyel tasarım tescil belgesi
Registration certificate of industrial design



ENDÜSTRİYEL TASARIM TESCİL BELGESİ

TESCİL NO: 2002 82347
TAKSİT

Tasarım Sahibi: ÇAĞRI ENDÜSTRİ MALLARI PAZARLAMA YATIRIM SANAYİ VE TİCARET ANONİM ŞİRKETİ
YATIRIMCI VE İHRAÇÇISI

Adres: Davutpaşa Cad. No:14 Kat:2 ÜMRANİYE İLİ İSTANBUL

Takvimi: 18 aydır

Markanın Korunması Hakkında 506 Sayılı Kanun Hükmünde Kararnameyle 30.03.2008 Tarihinde Bkazanılan CN V.ii. maddesi ile korunan markadır.

Endüstriyel tasarım tescil belgesi
Registration certificate of industrial design



FAYDALI MODEL BELGESİ

No: TR 2003 00089 V

Bu belge, 551 sayılı Patent Hakkında Kanun Hükmünde Kararname ile 16.02.2004 tarihinde çıkarılan CN V.ii. maddesi ile korunan markadır.

Dr. Yusuf BAĞCI
Ticari Hukukçu
Tatlısu Mahallesi
No:16 Daire:13 Kat:06 Ümraniye/İstanbul



ОРГАН ПО СЕРТИФИКАЦИИ ПРОДУКЦИИ ОБЩЕСТВО С ОГРАНИЧЕННОЙ ОТВЕТСТВЕННОСТЬЮ "СЕРКОНС"

Аттестат аккредитации: № РОСС RU.0001.11AB28
113114, Москва, ул. Дербеневская наб., д. 11, пом. 60, Россия.
Тел.: +7 (495) 782 1708, факс: +7 (495) 782 1701.
Сайт: www.asbort.com.ru, e-mail: info@serkons.com

Исх. № 01-14/182 от 18.06.2014 г.

"ÇAĞRI ENDÜSTRİ MALLARI PAZARLAMA YATIRIM SANAYİ VE TİCARET A.Ş."

Адрес: Davutpaşa Caddesi No:14/1 34010 Topkapı-İSTANBUL/Турция

Информационное письмо

Орган по сертификации продукции ООО «СЕРКОНС» (аттестат аккредитации № РОСС RU.0001.11AB28) информирует Вас о том, что в соответствии с Постановлением Правительства РФ от 1 декабря 2009 г. N 982 «Об утверждении единого перечня продукции, подлежащей обязательной сертификации, и единого перечня продукции, подтверждение соответствия которой осуществляется в форме принятия декларации о соответствии», введенным в действие с 15.02.2010 г. указавшим ниже продукцией, **не подлежит** подтверждению соответствия, а так же **не является** объектом обязательного подтверждения соответствия по техническому регламенту Таможенного союза «О безопасности машин и оборудования» (ТР ТС 010/2011), утвержденного Решением Комиссии Таможенного союза от 18.10.2011 N 823:

Наименование продукции	Код ОКП, ТН ВЭД
Контрейлерные элементы и ленты в.м. «ALHAN»	8431 39 000 0

Оформление сертификата соответствия и принятие декларации о соответствии не требуется.

Руководитель ООС:  А. А. Григорьев

СИСТЕМА СЕРТИФИКАЦИИ ГОСТ Р
ФЕДЕРАЛЬНОЕ АГЕНТСТВО ПО ТЕХНИЧЕСКОМУ РЕГУЛИРОВАНИЮ И МЕТРОЛОГИИ

СЕРТИФИКАТ СООТВЕТСТВИЯ

№ РОСС ТР.ММ.04.1810468
Срок действия с 19.06.2014 по 18.06.2017
№ 1627188

ОРГАН ПО СЕРТИФИКАЦИИ рег. № РОСС RU.0001.113M04 Орган по сертификации продукции ООО "ТНТЛ Станарт" в качестве: РФ, 115114, г. Москва, Дербеневская наб., д. 11, помещение 60. Телефон (495)777-80-28, факс (495)777-80-28, адрес электронной почты tkaz@tnto-rl.ru.

ПРОДУКЦИЯ Контрейлерные элементы и ленты в.м. «ALHAN»
См. приложение на 1 листе, глава № 0521109.
Серийный выпуск: 31 6900

СООТВЕТСТВУЕТ ТРЕБОВАНИЯМ НОРМАТИВНЫХ ДОКУМЕНТОВ
ГОСТ 12.2.003-91

ИЗГОТОВИТЕЛЬ «ÇAĞRI ENDÜSTRİ MALLARI PAZARLAMA YATIRIM SANAYİ VE TİCARET A.Ş.»
Адрес: Davutpaşa Caddesi No:14/1 34010 Topkapı-İSTANBUL, Турция.
Телефон (+90 212)444 00 42, факс (+90 212)501 54 05.
СЕРТИФИКАТ ВЫДААН «ÇAĞRI ENDÜSTRİ MALLARI PAZARLAMA YATIRIM SANAYİ VE TİCARET A.Ş.»
Адрес: Davutpaşa Caddesi No:14/1 34010 Topkapı-İSTANBUL, Турция.
Телефон (+90 212)444 00 42, факс (+90 212)501 54 05.

НА ОСНОВАНИИ протокола сертификационных испытаний № 11066 от 18.06.2014 г.
Испытательный центр ООО «АКАДЕМСКИЙ» (дочернее предприятие № РОСС RU.0001.21AB09 от 01.08.2011 до 01.08.2016, адрес: 630024, Новосибирская обл., г. Новосибирск, ул. Белинская, д. 14

ДОПОЛНИТЕЛЬНАЯ ИНФОРМАЦИЯ Сертификат системы менеджмента качества ISO 9001:2008 № 01/10077/05-TR от 27.02.2014 г., выданный ОС «ASB»
Срок действия: 3.

Руководитель органа:  П. П. Филатов
Эксперт:  Б. И. Чижиков

Сертификат не применяется при обязательной сертификации





ÇAĞRI[®]
ENDÜSTRİ A.Ş.

ALHAN[®]

www.alhan-cagri.com

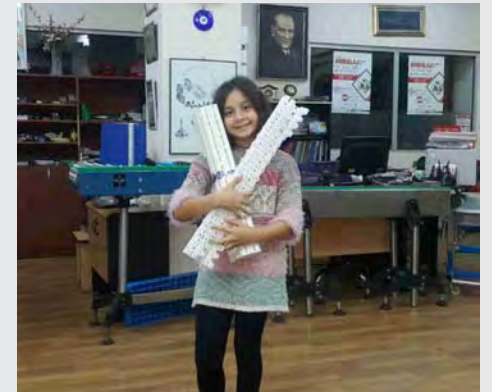
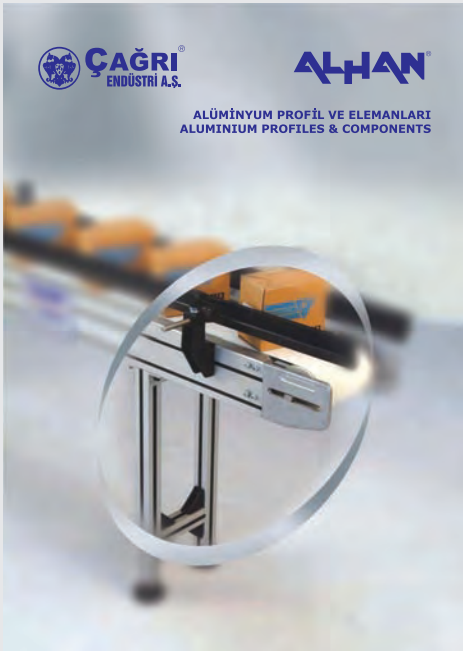

“Ey yükselen yeni nesil, gelecek sizindir. Cumhuriyeti biz kurduk; onu yükseltecek ve sürdüreceksiniz.”

H. Atatürk

Üretimden Satış / From Production to Sales



Tarihçe / History

ÇAĞRI ENDÜSTRİ A.Ş., 1978 yılında Gültekinoğlu Sâlih Özbideciler tarafından İstanbul'da kurulmuş olup 1994 yılından itibaren konveyör modüller (hasır) bantları ve hazır makine parçalarını üretmektedir. **ALHAN**® markasıyla üretim yapmaktayız.

CAGRI IND. INC. was founded in 1978 in Istanbul, Turkey. Our company is leading manufacturer of modular belts and conveyor components since 1994. Our trade mark is "**ALHAN**®"



Sektörler / Sectors

Gıda Sektörü
Food Industry



Otomotiv Sektörü
Automotive Industry



Et Ürünleri Sektörü
Meat Products Sector



İlaç Sektörü
Pharmaceutical Industry



Süt Ürünleri Sektörü
Dair Products Sector



Sebze Meyve Sektörü
Fruit and Vegetable Sector



Meşrubat ve Konserve Sektörü
Soft Drinks and Canned



Deniz Sektörü
Sea Products Sector



Düşük Sürtümlü Asetal/Low Friction Acetal (LF)

Termoplastik grubundan olan bu malzeme düşük sürtünme katsayısı ve yüksek gerilme değerlerine sahiptir. Dönüşlü ve düz konveyör bantlarında kullanılan bu malzemenin gıdaya uygunluk belgesi bulunmaktadır.

This is a thermoplastic material with special additives providing low coefficients and high tensile strength. This material's specific components make it ideally suited for use in curved-route chains. Material with certificate FDA.

Asetal/Acetal(D)

Oldukça yüksek mekanik özelliklere sahiptir. İçerik olarak herhangi bir katkı maddesi bulunmamakla birlikte gıdaya uygunluk sertifikası bulunmaktadır.

This thermoplastic has extremely good mechanical properties. It is used without any special additives. Material with certificate FDA.

Güçlendirilmiş Polipropilen/Reinforced Polypropylene (PP+FV)

Cam elyaf katkılı polipropilendir. Kimyasallara karşı dayanımı yüksektir.

Fibre-glass reinforced polypropylene. This material is highly resistant to chemical agents.

Polyamid/Polyamide(PA6)

Yüksek gerilme özelliğine sahip olan bu malzemenin ses azaltıcı özelliği bulunmaktadır.

This material has high tenacity and good noise absorption polyamide.

Güçlendirilmiş Polyamid/Reinforced Polyamide

Cam elyaf katkılı olan bu malzemenin mekanik ve ısıl özellikleri artırılmıştır.

Polyamide variant with mechanical and thermal properties improved.

Alpolen®UHMW

Yüksek moleküler ağırlığa sahip olan alpolen düşük sürtünme katsayısı ile sürtünme profilleri ve zincir kızıkları elemanlarında kullanılmaktadır. Gıdaya uygunluk sertifikası bulunmaktadır.

The ultra high molecular weight alpolen is the material more used in friction applications in view of its piece-quality relation. It can be used in sliding guides and friction profiles.

PBT

Normal şartlar altında su geçirgenliği neredeyse sıfır olan bu malzemenin mekanik ve ısıl özellikleri de oldukça yüksektir. Daha çok rulman yataklarında kullanılmaktadır.

It has high water absorption furthermore good mechanical and thermal properties.

Katalogtaki ürünlerin tasarımları değişikliğe uğrayabilir ve değişiklikten doğabilecek sorunlardan firmamız sorumlu değildir. In catalogue, our product's design will be changed and as a result of this we have no response.

805

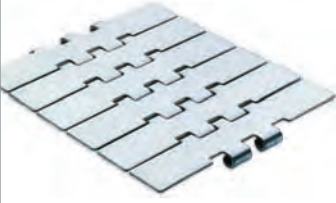

Çift Mentşeli
Paslanmaz Bantlar
Double Hinges Plastic Chains

810



Düzgün Doğrusal
Paslanmaz Çelik Bant
Stainless Chains

815



Düzgün Doğrusal
Paslanmaz Çelik Bant
Stainless Chains

815 G



Kauçuk Bantlı
Paslanmaz Kulaksız Bant
Stainless Chains

808 RUL



Makaralı Zincir Bantı
Roller Chains

881 A



Açılı Kulaklı
Dönüşlü Paslanmaz Bant
Plate Chains for Curved Conveyor

881 T



TAB Kulaklı Dönüşlü
Paslanmaz Bant
Plate Chains for Curved Conveyor

881 M



Manyetik Dönüşlü
Paslanmaz Bant
Plate Chains for Curved Conveyor

350 TI2



İki Parçalı Düzgün Doğrusal Paslanmaz
Bant Tahrik Dişlisi (Talaşlı İmalat)
Split Sprockets

380 825



Paslanmaz Dönüşlü Bant Tahrik Dişlisi
Split Sprockets

371 KDT



TAB Kulaklı Dönüşlü Paslanmaz
Bant Dişlisi (Talaşlı İmalat)
Split Sprockets

328 KI1



Z19 Plastik Tek Parça
Bant Tahrik Dişlisi
Split Sprockets

871



Düzgün Doğrusal 30 mm
Asetal Bakla Bant
Plate Chains

374 015



30'luk Asetal Bakla Bant
Dişlisi (TV Bantı-Talaşlı İmalat)
Driving Sprockets

821



Düzgün Doğrusal Ağır Tip Çift
Mentşeli Asetal Bakla Bant
Double Hinges Chains

395 CMT



Çift Mentşeli Asetal ve Paslanmaz
Bant Dişlisi (İki Parçalı-Talaşlı İmalat)
Split Sprockets

820



Düzgün Doğrusal Bakla Bant
Straight Plate Chains

880 TGO



Tırnaklı Manyetik
Dönüşlü Bant
Plate Curved for Curved Conveyor

880 TBG



TAB Kulaklı Dönüşlü Bant
Plate Curved for Curved Conveyor

880 TGT



Tırnaksız Manyetik Dönüşlü Bant
Plate Curved for Curved Conveyor

882



Ağır Tip Tab Kulaklı
Dönüşlü Bakla Bant
Plate Curved for Curved Conveyor

304 021



Avare Kasnak
Driving Sprockets

312 KI2



İki Parçalı Plastik
Bant Tahrik Dişlisi
Split Sprockets

314 KI2



İki Parçalı Paslanmaz Bant
Tahrik Dişlisi
Driving Sprockets

821 BPM

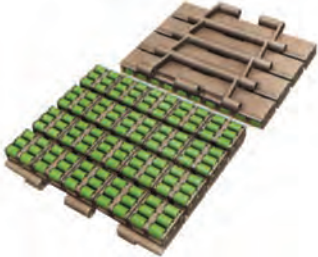

Boncuk Makaralı
Düzgün Doğrusal Bantlar
Staringht Roller Chains

882 BPT



Boncuk Makaralı Dönüşlü Bantlar
Curve Roller Chains

885 SKM

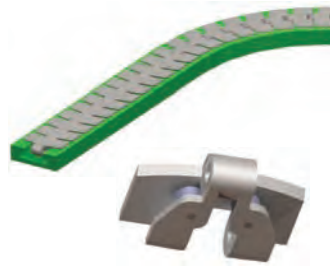

Boncuk Makaralı Bant
Sideflexing Chain For Curver Conveyors

854



Kulaklı Kasa Taşıma Bantı
Crate Conveyor Chains

320 TI2



İki Parçalı Plastik Bant
Dişlisi (Talaşlı İmalat)
Split Sprockets

386 KDT



Asetal Dönüşlü Bant
Tahrik Dişlisi (Talaşlı İmalat)
Split Sprockets

385 H25



Dönüşlü Plastik Bant Hafif-Ağır Tip
Tek Parça Tahrik-Avare Dişlisi
Light-Heavy Driving & Idler Sprocket

302 019



Avare Kasnak
Idler sprockets

184 3GO



Asetal Zincir Bant
Plate Top Chains with Base Roller Chains

1873



Asetal Zincir Bant
Plate Top Chains with Base Roller Chains

1874



Asetal Zincir Bant
Plate Top Chains with Base Roller Chains

843



Asetal Zincir Bant
Plate Top Chains with Base Roller Chains

863 G00



Asetal Zincir Bant
Plate Top Chains with Base Roller Chains

880 BYO



Yarasa Bant (Düz Kulaklı)
Plain Chains

881 BYO



Yarasa Bant (Silindir Kulaklı)
Plain Chains

374 KDS



Silindir Kulaklı Yarasa Bant
Dişlileri (Tek Parça-Talaşlı İmalat)
Drive Sprockets for Flex Chains

863 GKO



Tırnaklı Kauçuk Bant
Rubber Chains

853 B00



853 Kulaklı Kasa Taşıma
Bantı (Ağır Tip)
Crate Chains (Heavy Type)

854 B00



854 Kasa Taşıma
Götürücülü Bantı (Ağır Tip)
Crate Chains (Heavy Type)

857 B00



857 Düz Kasa
Taşıma Bantı
Crate Chains

858 B00



858 Kulaklı Kasa
Taşıma Bantı
Crate Chains

859 B00



859 Kasa Taşıma
Götürücülü bantı
Crate Chains

380 D....



Kasa Taşıma Bantı Dişlisi
Sprocket for crate chains

853 D....



Kasa Taşıma Bantı Dişlisi
Sprocket for crate chains

860 BOO



860 Kulaklı (Kardenik)
Omurgalı Bant
Cardanic Chains

865 BOO



865 Kulaksız (Kardenik)
Omurgalı Bant
Cardanic Chains

870 BOO



870 Kulaksız (Kardenik)
Omurgalı Bant
Cardanic Chains

875 BOO



875 Kulaksız (Kardenik)
Tırnaksız Omurgalı Bant
Cardanic Chains

876 BOO



876 Kulaksız (Kardenik)
Alt Tırnaklı Omurgalı Bant
Cardanic Chains

867 BOO



867 Kulaksız Omurgalı
Götürücülü Bant
Cardanic Conveyor Chains

318 T25



Kardenik Bant Avare Dişlisi
Drive Sprockets

338 T25



Kardenik Bant Tahrik Dişlisi
Split Sprockets

941 B01

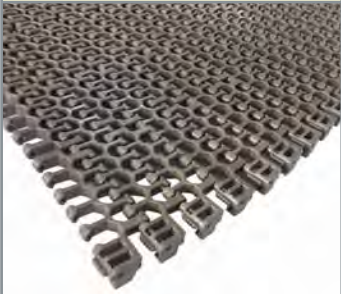

50,8 Dönüslü Hasır Bant
Spiral conveyor belts sprockets

381 ABB



50,8 Dönüslü Hasır
Bant Dişlisi
Split Sprockets

946

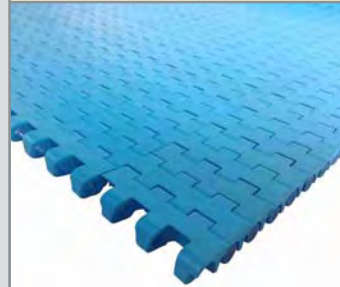

12,7 Hasır Bant
Modular Conveyor Belts

388



12,7 Hasır Bant Dişlisi
Modular Belts Driving Sprockets

940 B01

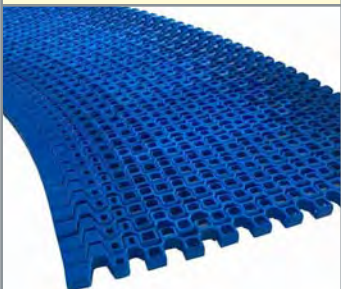

25,4 Dönüslü Hasır Bant
Spiral conveyor belts

380 ABB



25,4 Dönüslü Hasır
Bant Dişlisi
Split Sprockets

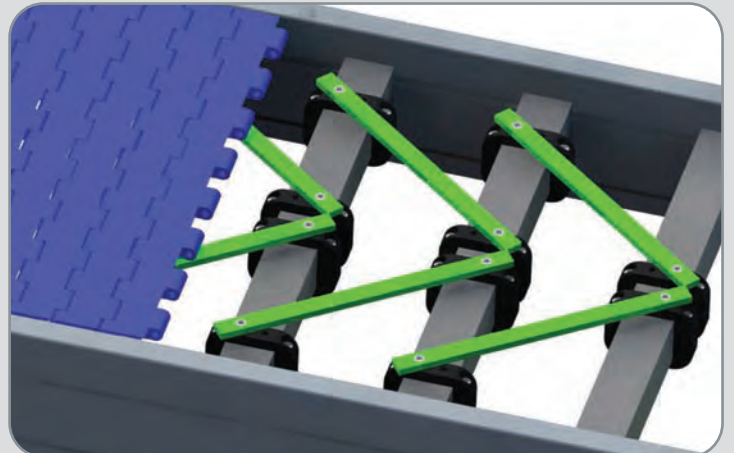

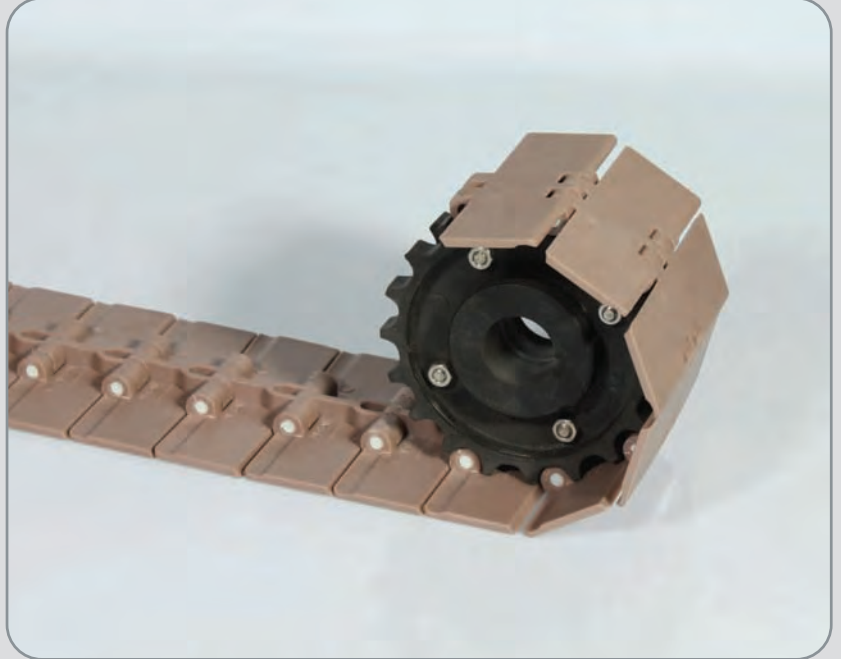
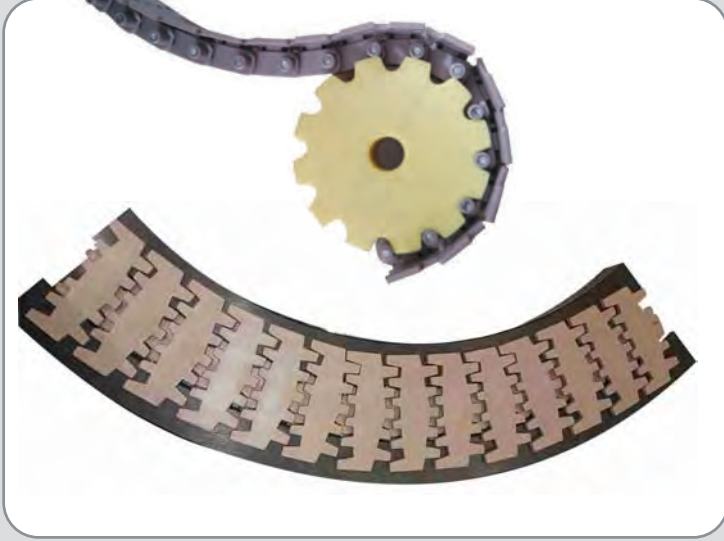

910

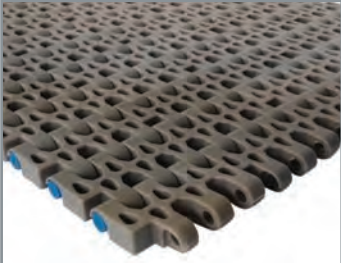

25,4 Damla Süzgeçli
Hasır Bant
Locked Drop Filter Modular Belt

361



25,4 Damla Süzgeçli
Hasır Bant Dişlisi
Split Sprockets

920

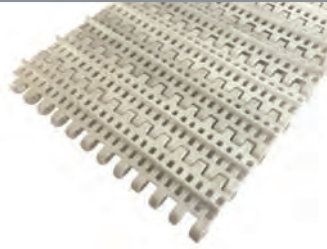

25,4 Kolay Temizlenebilir
Tırnaklı Hasır Bant
25,4 Easy to Clean Conveyor Belts

921

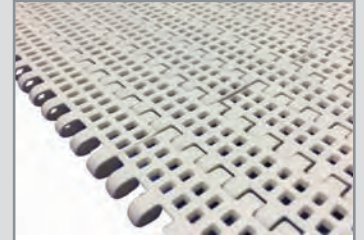

25,4 Küçük Süzgeçli Kolay
Temizlenebilir Hasır Bant
25,4 Easy to Clean Conveyor Belts

922



25,4 Büyük Süzgeçli Kolay
Temizlenebilir Hasır Bant
25,4 Easy to Clean Conveyor Belts

923



25,4 Düz Kolay
Temizlenebilir Hasır Bant
25,4 Easy to Clean Conveyor Belts

391



25,4 Kolay Temizlenebilir
Hasır Bant Dişlisi
Easy to Clean Conveyor Driving Sprockets

927



25,4 Kilitli Düz Hasır Bant
Locked Modular Conveyor Belts

931



25,4 Kilitli
Süzgeçli Hasır Bant
Locked Linear Filter Conveyor Belts

935

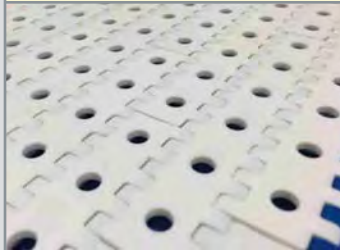

25,4 Kilitli Dairesel
Süzgeçli Hasır Bant
Locked Circular Filter Conveyor Belts

962

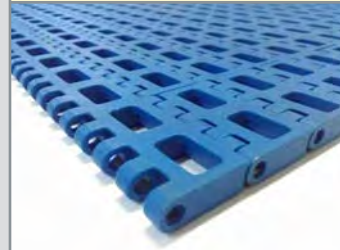

25,4 Kilitli
Mazgallı Hasır Bant
Open Grid Modular Conveyor Belts

822



25,4 Çok Mentşeli
Hasır Bant
Mold to Width

947

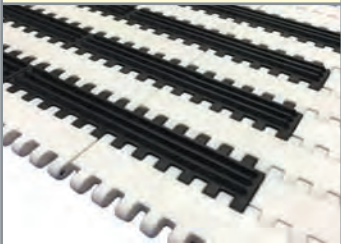

25,4 Hasır Bant için
Kauçuk Götürücü
Mini rubs rubber modular conveyor belts

937

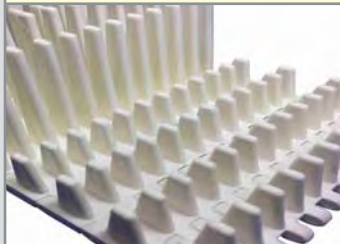

25,4 Hasır Bant
için Taraklı Götürücü
Cleats for modular conveyor belts

939

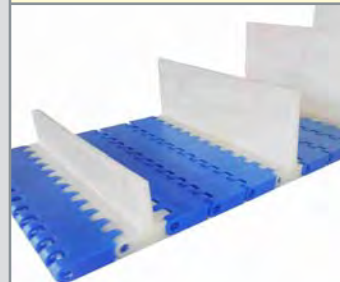

25,4 Hasır Bant için Götürücü
Cleats for Modular Conveyor Belts

381



25,4 Hatve Bant Tahrik Dişlisi
Split Sprockets

961



27,2 mm Hasırbant
Yükseltilmiş Izgaralı (Süzgeçli)
Raised Open Grid Modular Conveyor Belts

850



Geçiş Tarağı
Transition Cradle

965

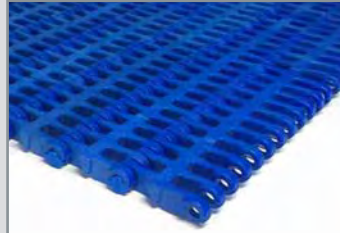

27,2 mm Hasırbant
Izgaralı (Süzgeçli)
Open Grid Modular Conveyor Belts

380 ABD



27,2 Hasır Bant Dişlisi
27,2 Sprockets for Modular Belts

845



38,1 Hasır Düz Taşıma Bantı
Modular Flat Top Conveyor Belts

862

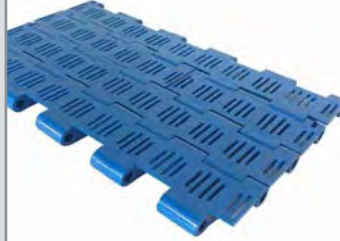

38,1 Izgaralı
(Süzgeç) Hasır Bant
Grid Modular Conveyor Belts

831



38,1 Kaburga Kanallı
Hasır Taşıma Bantı
Raised Rip Modular Conveyor Belts

833



38,1 Kauçuk Hasır Bant
Friction Top Chains (special series)

834



38,1 Hasır Bant
Taraklı Götürücüsü
Cleat Chains

855

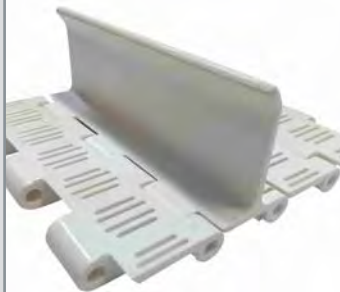

38,1 Hasır Bant Götürücüsü
Cleat Chains

850 C02



38,1 Bant Geçiş Tarağı
Transfers Combs

326



Kalıplı 38.1 Hatve Hasır
Bant Dişlisi (iki Parçalı)
Split Sprockets

360 T12



38,1 Hasırbant Dişlisi
(Talaşlı İmalat 2 parça)
Driving Sprockets

952



50,8 Hasır Düz Taşıyıcı
Bant (Ağır Tip)
Modular Flat Top Conveyor Belts

954

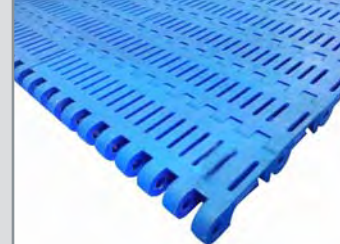

50,8 Hasır Süzgeçli
Taşıyıcı Bant (Ağır Tip)
Modular Flat Top Conveyor Belts

950



50,8 Yıldız Serisi Hasır
Düz Taşıyıcı Bant (Ağır Tip)
Star Serie Modular Conveyor Belts

963



50,8 Yumru Desenli
Hasır Bant (Ağır Tip)
Nub Top Modular Conveyor Belts

943

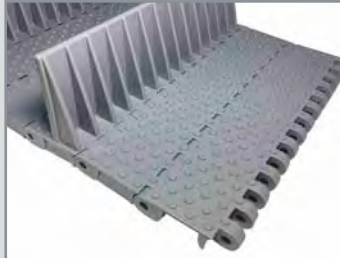

50,8 Engelli Götürücü
(Ağır Tip)
Cleat Chains

960

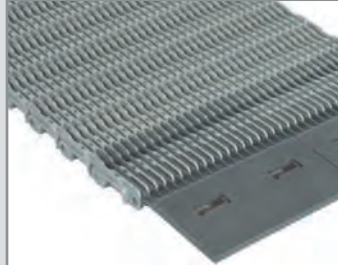

50,8 Kaburgalı Kanallı
Hasır Bant (Ağır Tip)
Raised Rip Modular Conveyor Belts

850

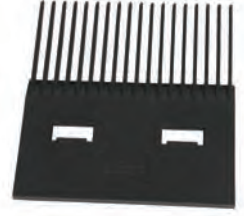

50,8 Hasır Bant
Geçiş Tarağı
Transfers Combs

956

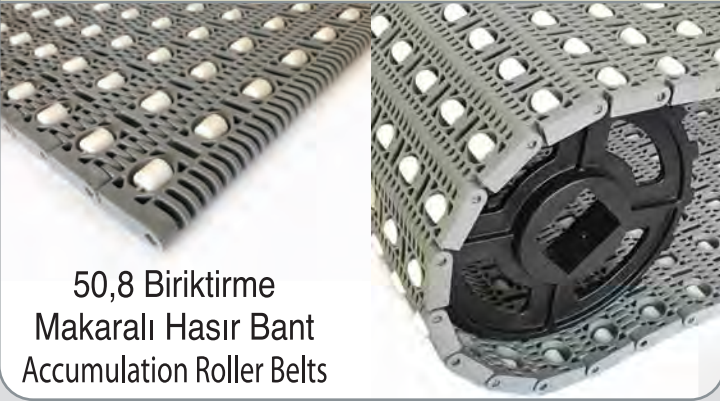

50,8 Biriktirme
Makaralı Hasır Bant
Accumulation Roller Belts

957



50,8 Aktarma Makaralı
Hasır Bant
Transfer Roller Belts

382



Z16 Tahrik Dişlisi
Split Sprockets

958



50,8 Dana Gözlü
Hasır Bant
Ball Modular Belts

383



Dana Gözlü Hasır Bant
Split Sprockets

999 EKO



Taşıyıcı Kova
Elevator Buckets

868 B01



Yan Kulak
Side Guards

980

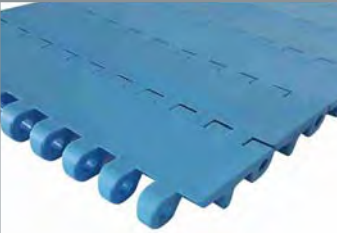

50,8 Kolay Düz
Temizlenebilir Bant
50,8 Easy to Clean Conveyor Belts

981



50,8 Süzgeçli Kolay
Temizlenebilir Bant
50,8 Easy to Clean Conveyor Belts

982

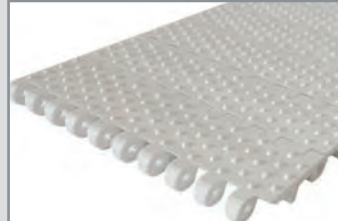

50,8 Yumru Desenli
Kolay Temizlenebilir Bant
50,8 Nub top Modular Conveyor Belts

983

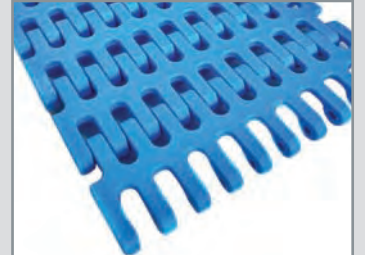

50,8 Izgaralı Kolay
Temizlenebilir Bant
50,8 Easy to Clean Conveyor Belts

984

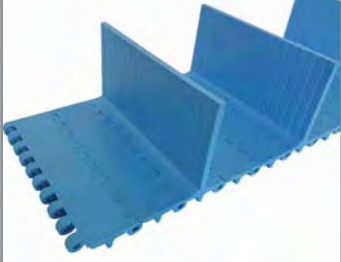

50,8 Götürücülü Kolay
Temizlenebilir Bant
50,8 Easy to Clean Conveyor Belts

389



50,8 Hatve Kolay Temizlenebilir
Hasır Bant Dişlisi
Easy to Clean Conveyor Driving Sprockets

800 167 077



Aktarma Tavası
Modular Transfer Plates with Rollers

800 167 078



Aktarma Tavası
Modular Transfer Plates with Rollers

800 167 070



Aktarma Tavası
Modular Transfer Plates with Rollers

800 167 071



Aktarma Tavası
Modular Transfer Plates with Rollers

800 167 072



Aktarma Tavası
Modular Transfer Plates with Rollers

800 167 073



Aktarma Tavası
Modular Transfer Plates with Rollers



800 235 040



Dişli Sabitleme
Kelepçesi (Kare)
Square

800 235 350



Dişli Sabitleme
Kelepçesi (Yuvarlak)
Circle

207 GYR

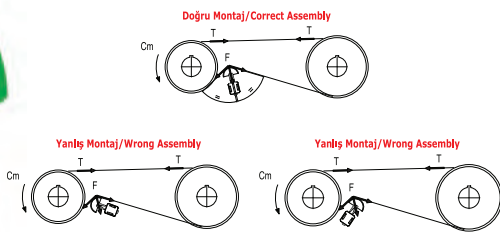

Zincir Gergi Aparatı
Chain Tensioner

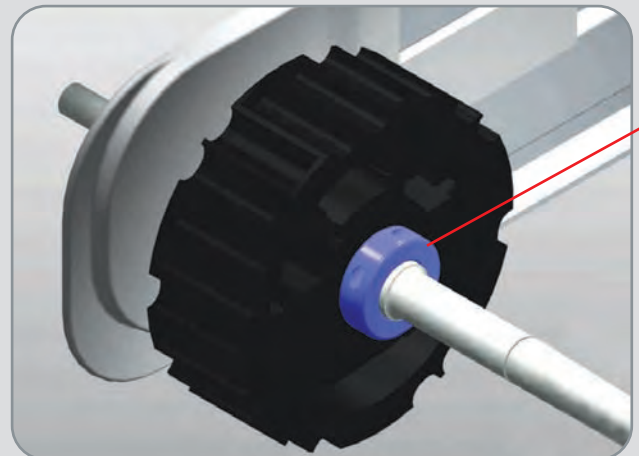

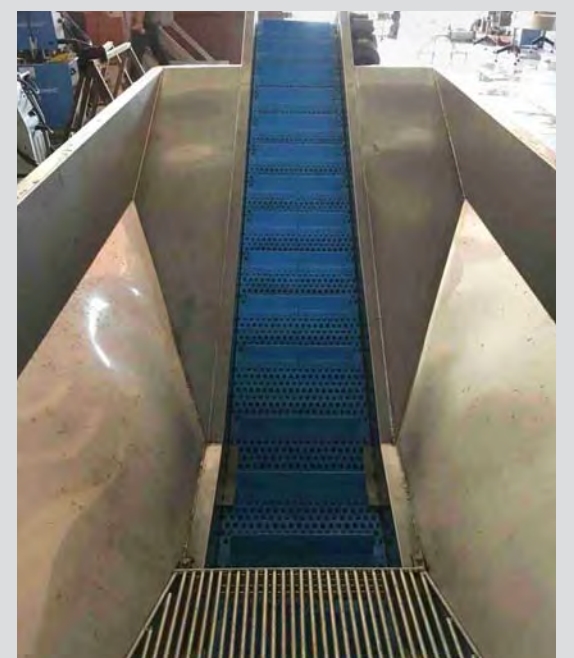
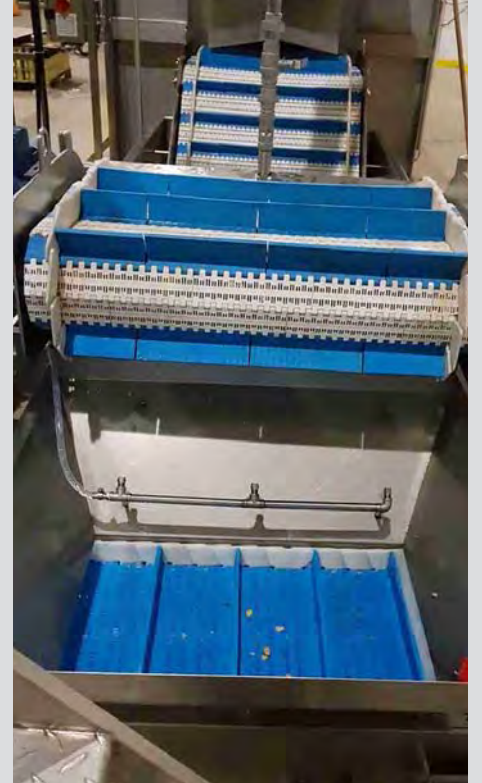
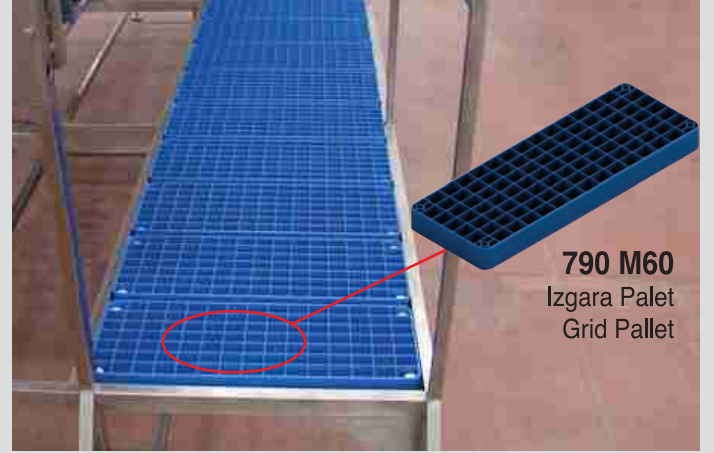
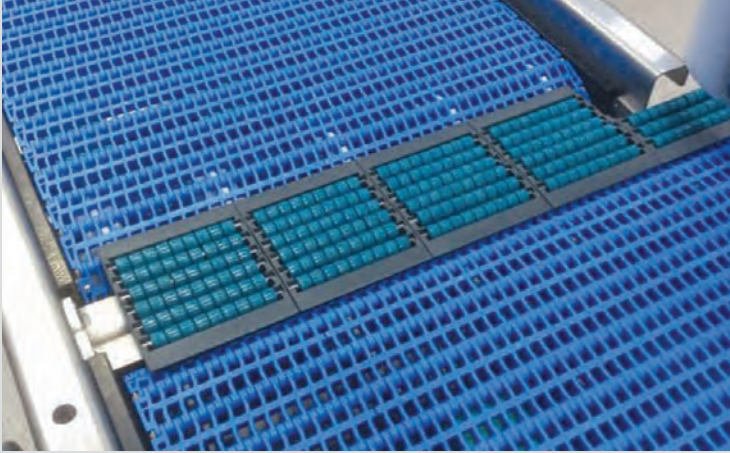

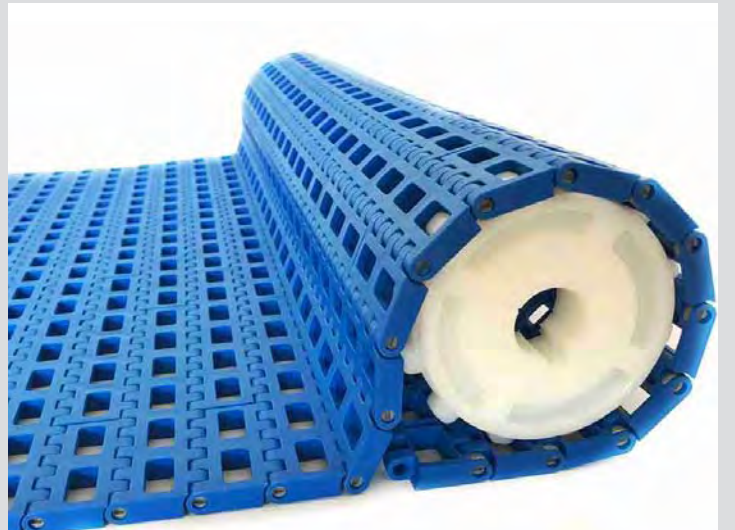
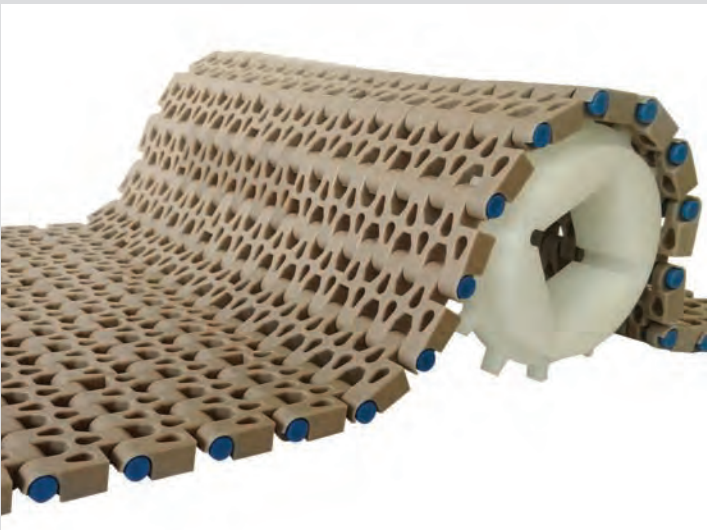
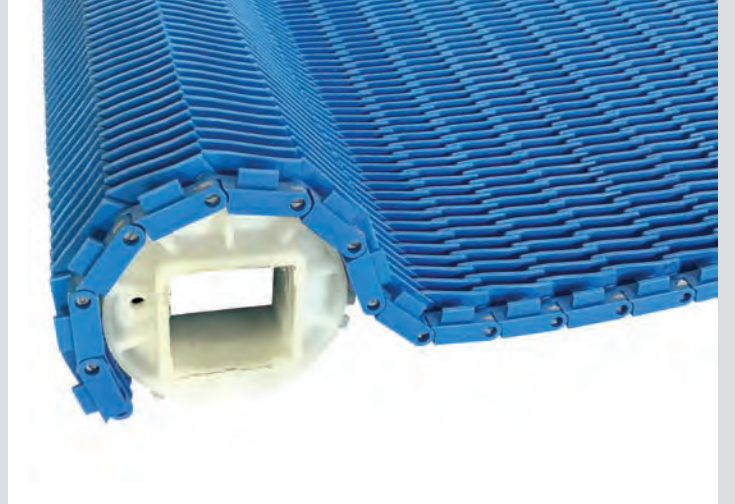
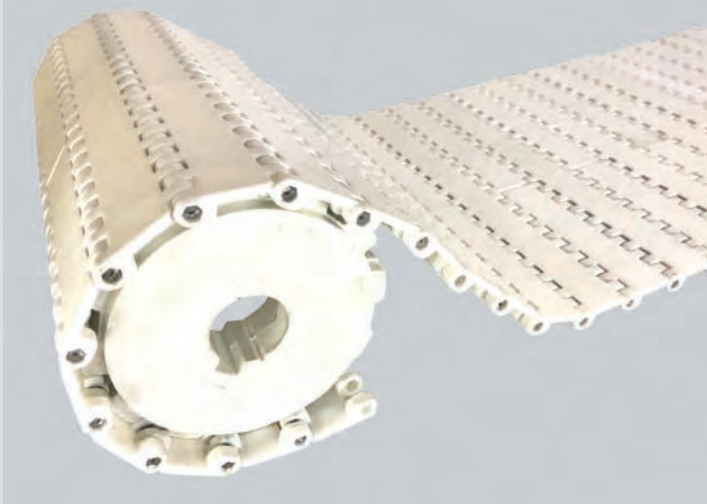
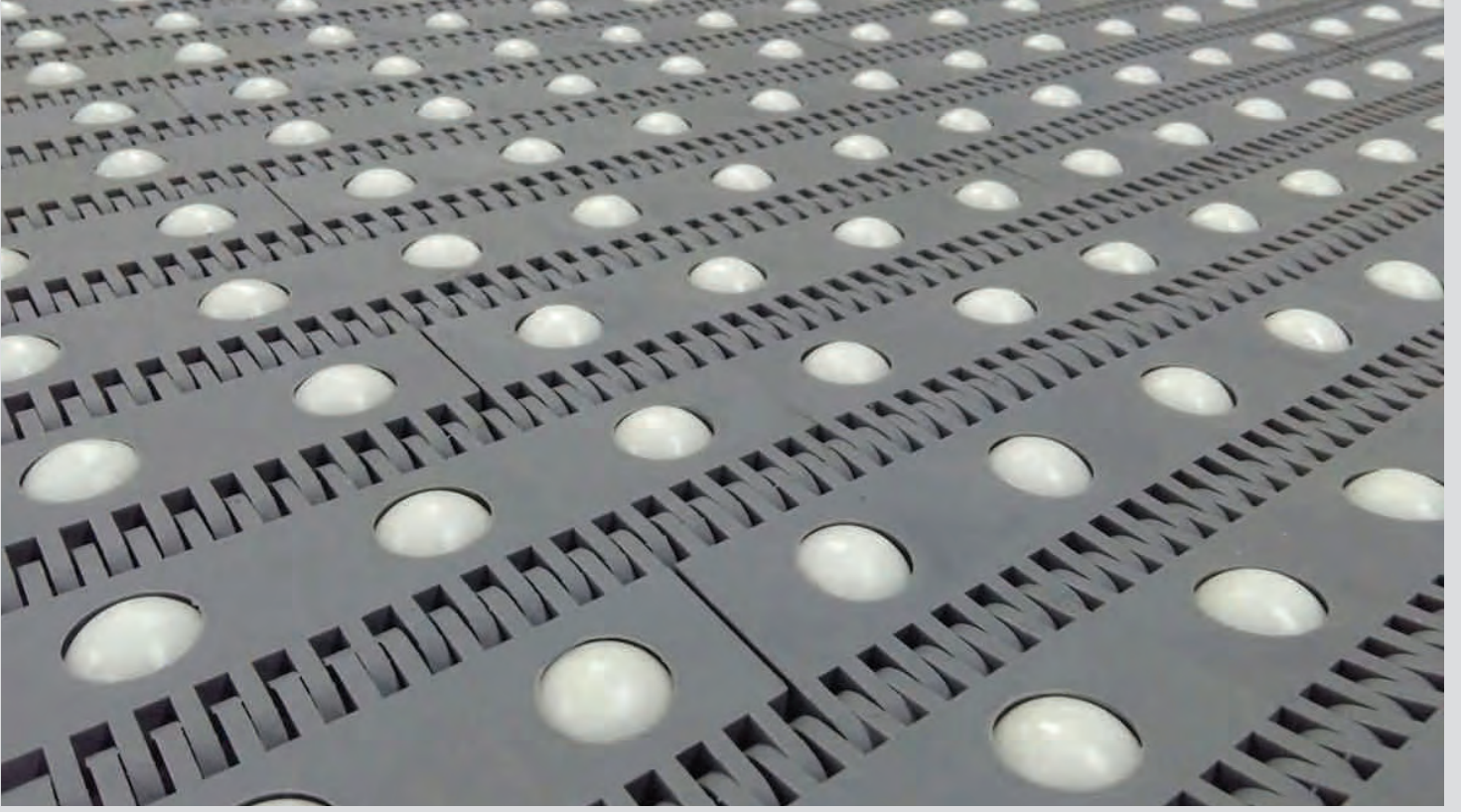

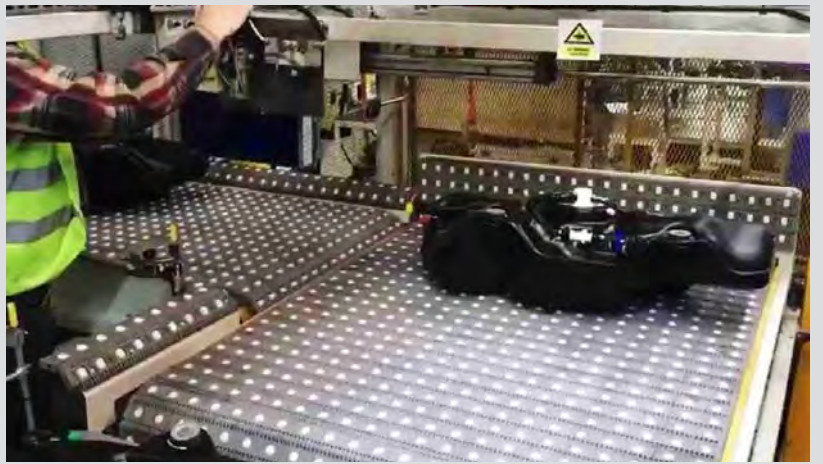
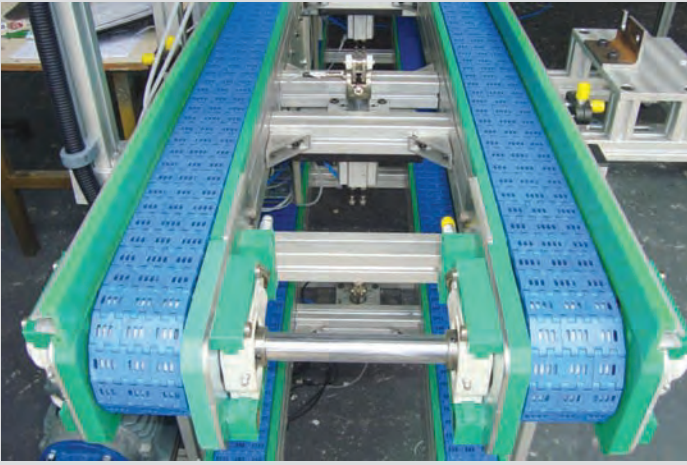
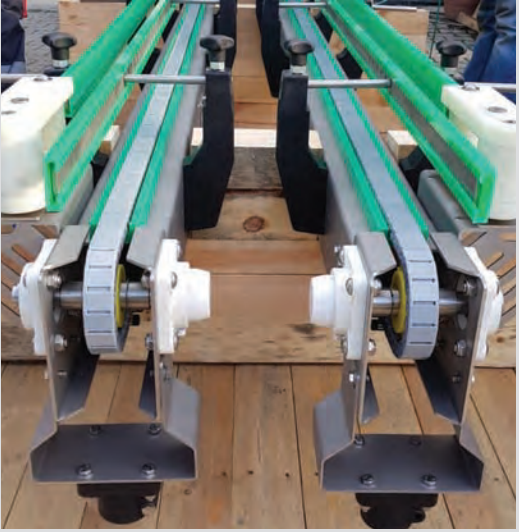

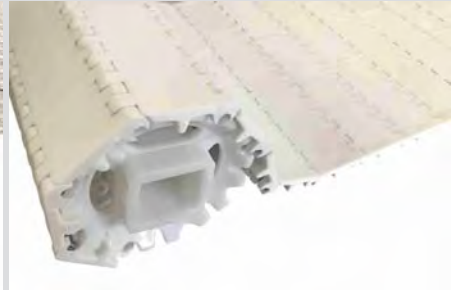
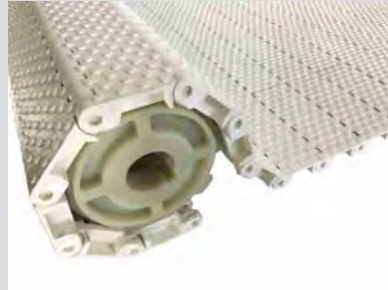
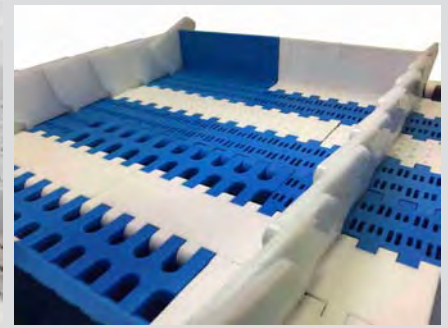
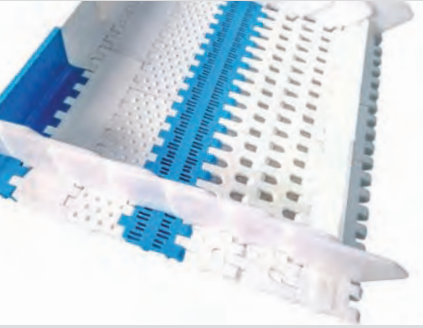
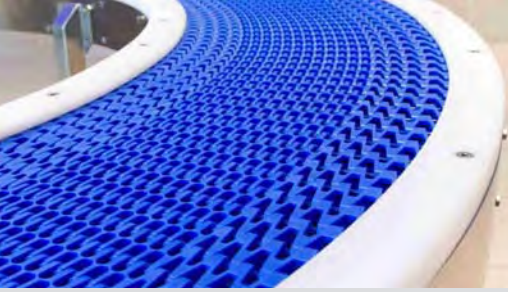

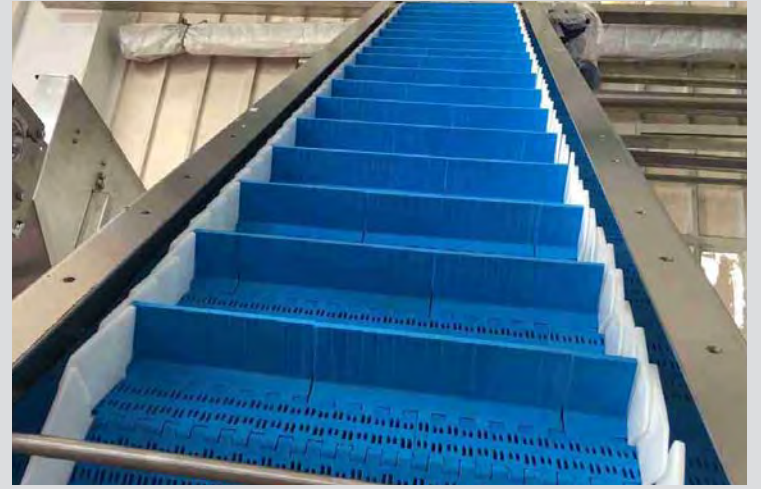
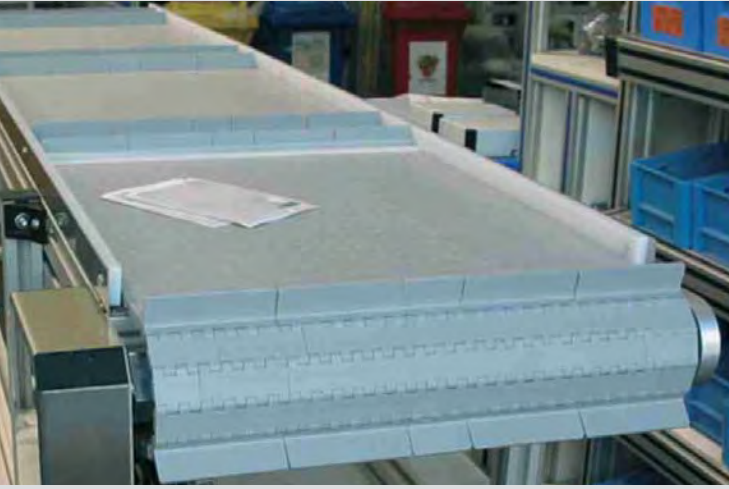
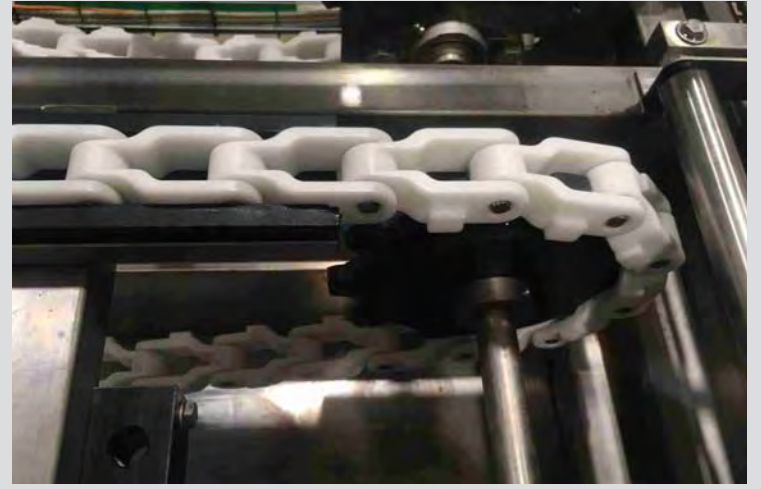
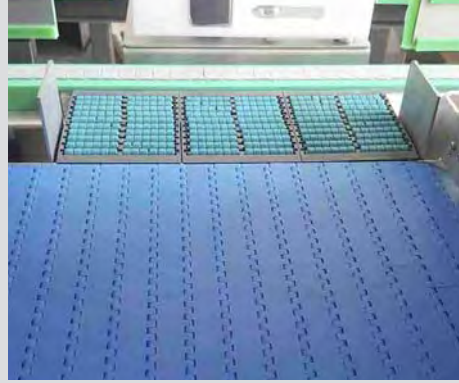

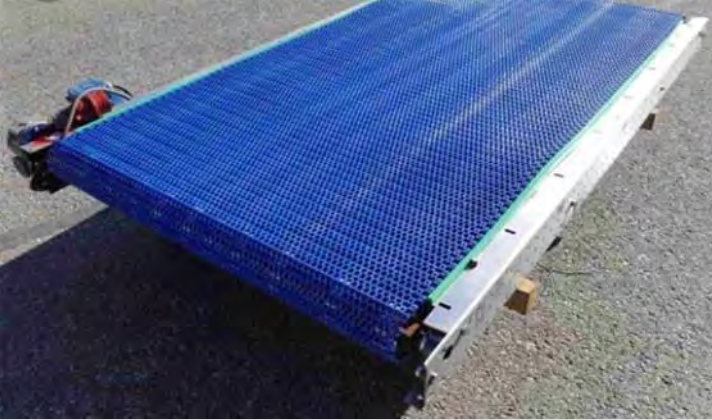
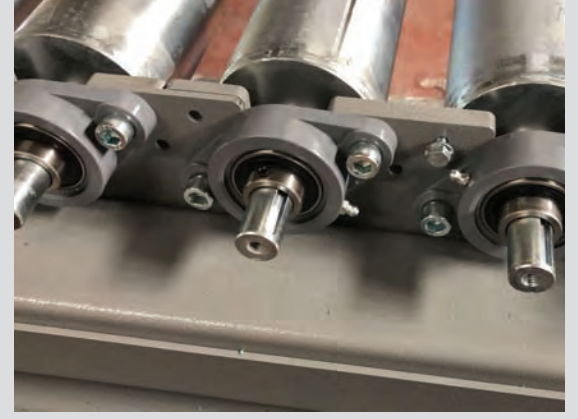

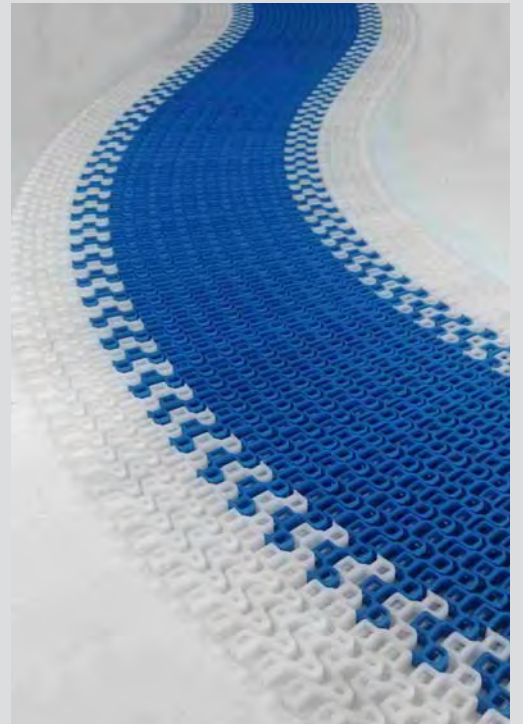
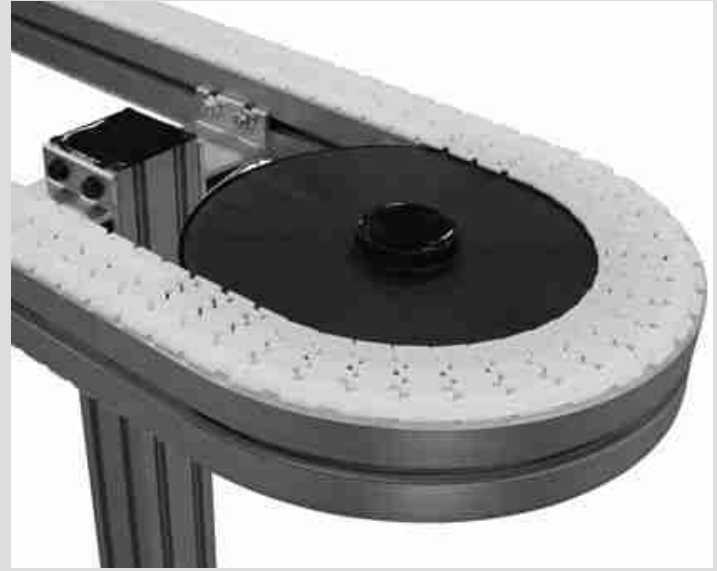
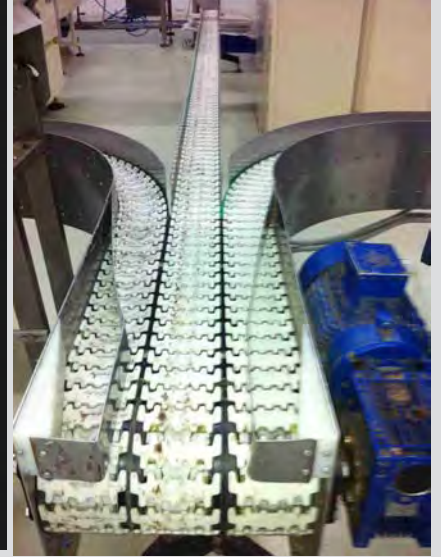

950-951 YILDIZ SERİSİ HASIR DÜZ TAŞIYICI BANT/STAR SERIE MODULAR CONVEYOR BELTS



Yeni
New



50.8 mm

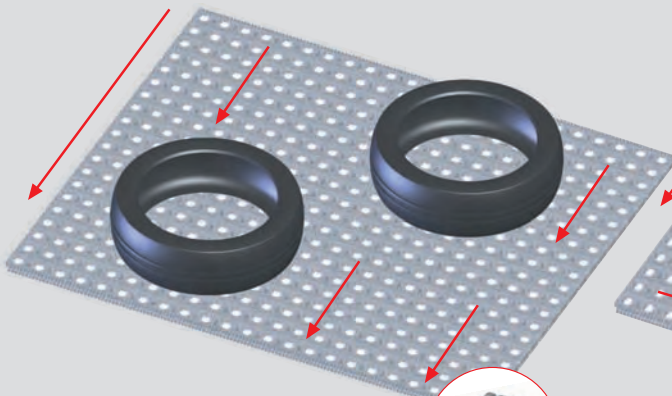
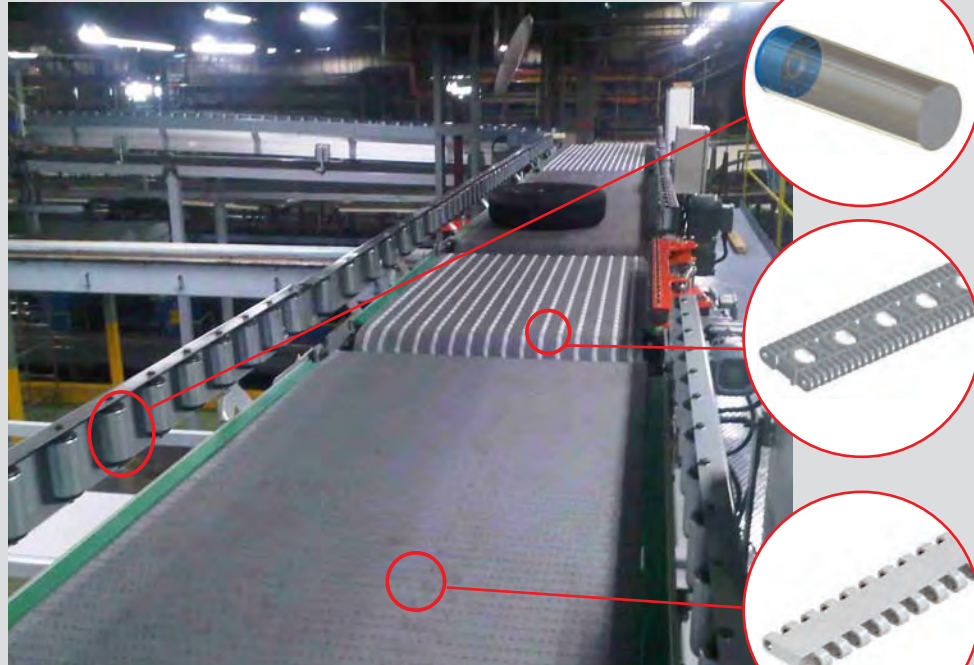
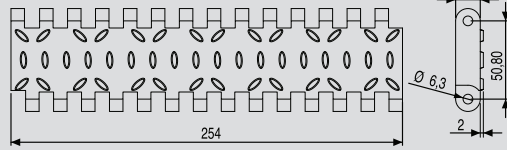

956 BİRİKTİRME
MAKARALI HASIR BANTI
ACCUMULATION ROLLER BELTS

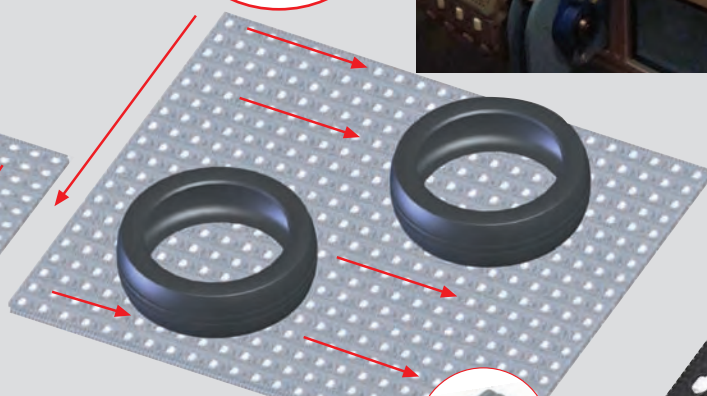

957 AKTARMA
MARAKALI HASIR BANT
TRANSFER ROLLER BELTS

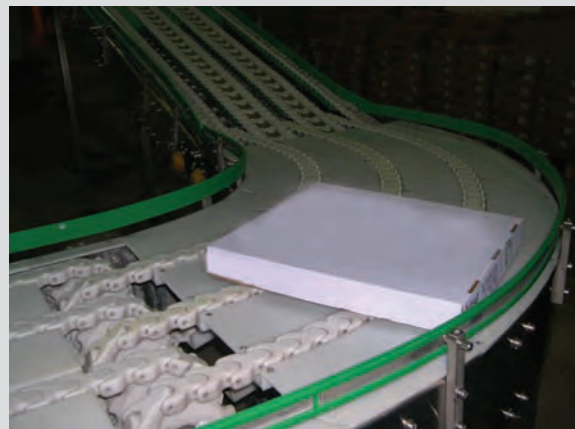
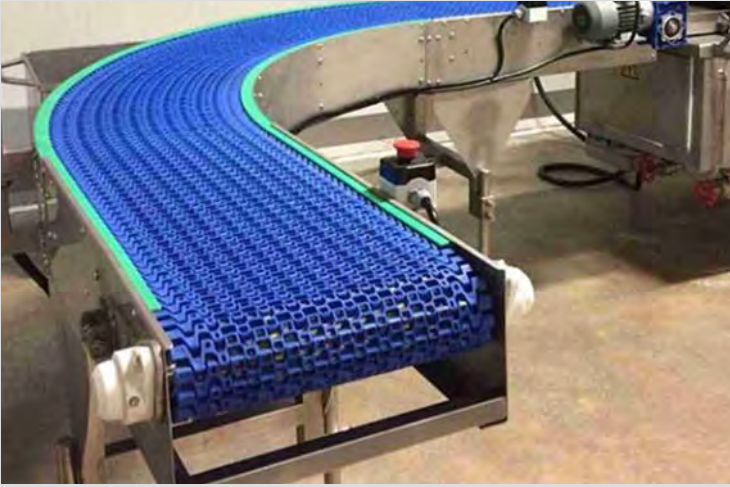

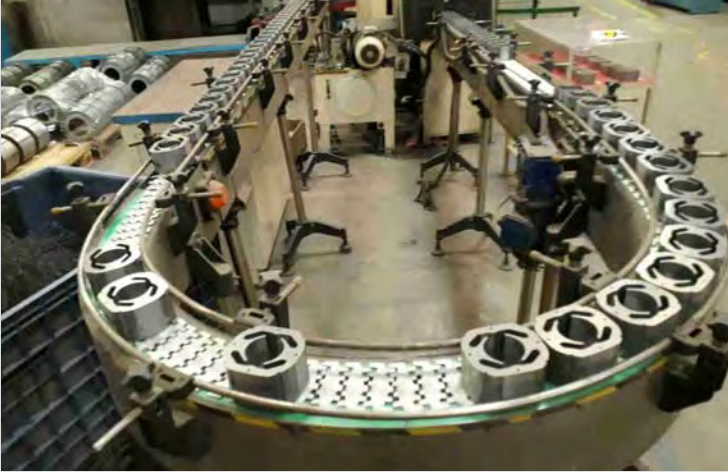

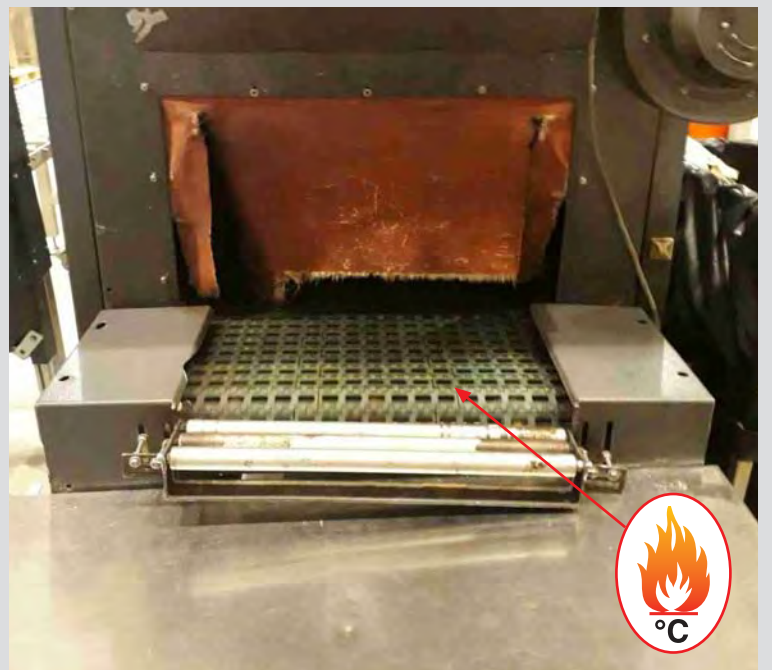
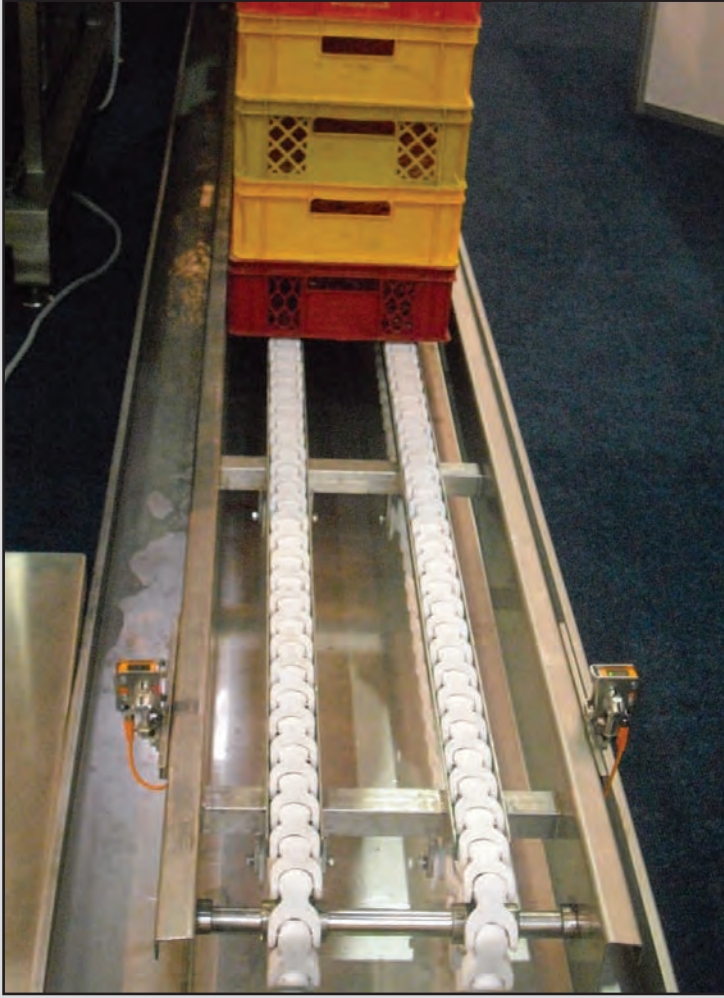

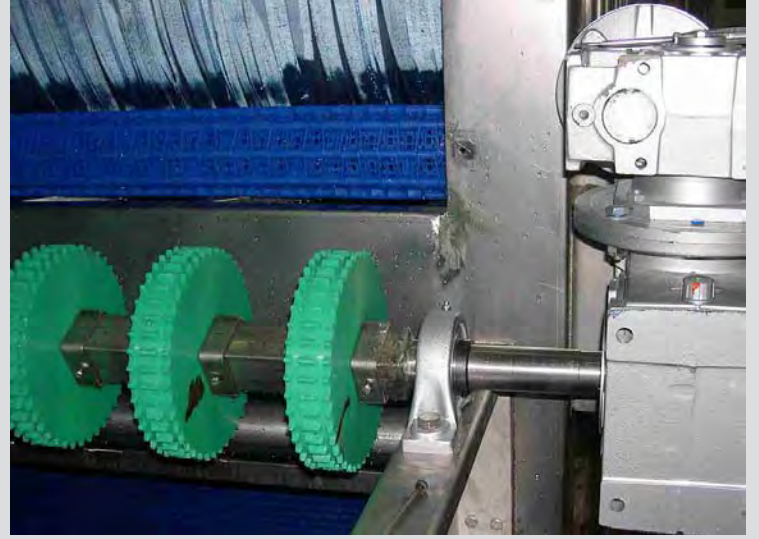
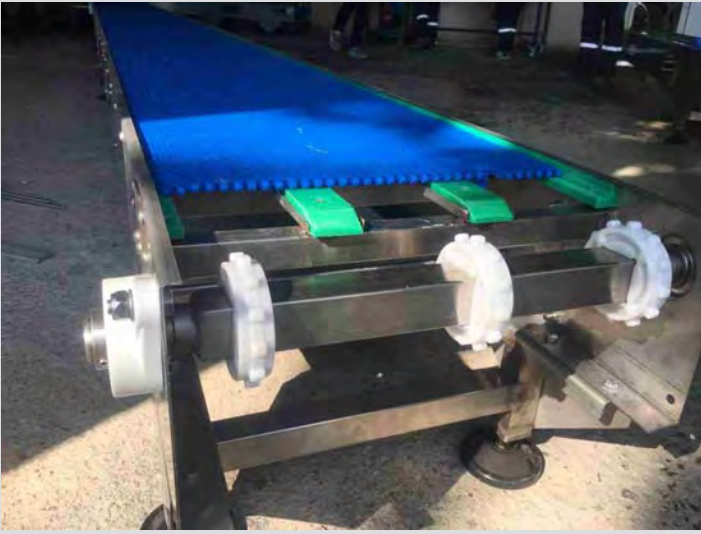

206 OÖZ



Z Profil Alpolen
Guides for Bottling and Packaging

206 LMY



Düz Lama Profil Alpolen
Flat Guides

206 OGZ

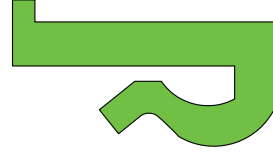

Geçmeli Z Profil Alpolen
Guides for Bottling and Packaging

206 GLA

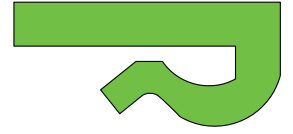

Geçmeli Profil Alpolen
Guides for Bottling and Packaging

206 UO T

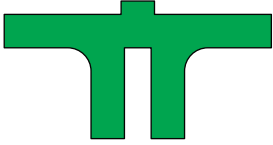

Tca Profil Alpolen
Guides for Bottling and Packaging

206 OOL



L Profil Alpolen
Guides for Bottling and Packaging

206 OTL



L/600 Profil Alpolen
Guides for Bottling and Packaging

206 OOT



T Profil Alpolen
Guides for Bottling and Packaging

207 DON

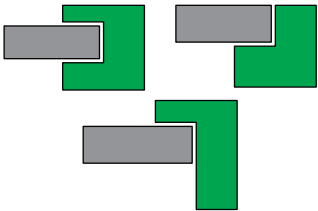

Alpolen 1000 Sürtünme Profilleri
Guides for Bottling and Packaging

206 DOT



Tcal Profil Alpolen 1000
Guides for Bottling and Packaging

207 HC



Alpolen 1000 Çelik Profilli HCC Kızakları
Guides for Bottling and Packaging

207 CC



Alpolen 1000 Çelik C Sürtünme Profilleri
Guides for Bottling and Packaging

207 OKT



Kulaklı T Profil Alpolen
Guides for Bottling and Packaging

206 YD3



C Profil Alpolen
Guides for Bottling and Packaging

206 YU1

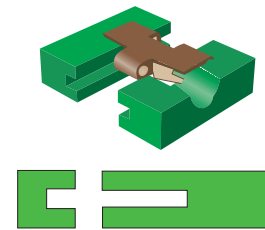

C Profil Alpolen
Guides for Bottling and Packaging

206 BSA

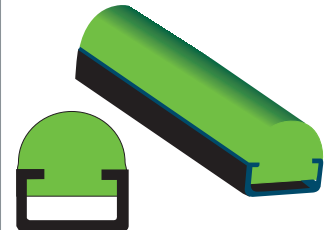

Yuvarlak Balık Sırtı Profil Alpolen
Guides for Bottling and Packaging

206 OOC

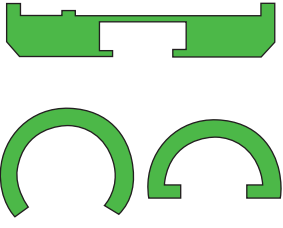

U/650 Profil Alpolen
Guides for Bottling and Packaging

207 OT...

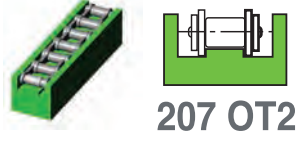

Alpolen T Model Zincir Kızakları
Roller Chain Guides

207 TH2

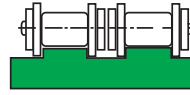

Alpolen 1000 2t Zincir Kızakları
Roller Chain Guides

207 TA4

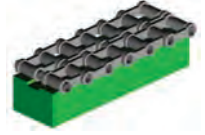

2T Ağır Tip Zincir Kızakları
Roller Chain Guides

207 OTT



TT Zincir Kızakları
Roller Chain Guides "TT"

207 B33

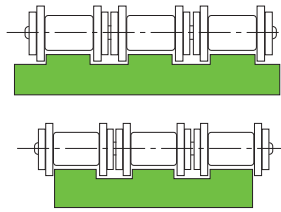

Alpolen 1000
3 Sıralı Zincir Kızakları
Roller Chain Guides "triple"

207 TCG

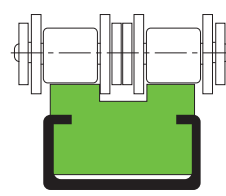

Alpolen 1000 TCG
2T Ağır Tip Zincir Kızakları
Roller Chain Guides "TCG"

207 UCC

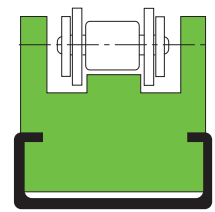

Alpolen 1000 UCC
Zincir Kızakları
Roller Chain Guides "UCC"

207 UCD

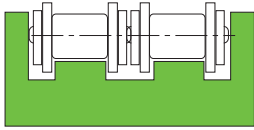

Alpolen 1000 UCD
Zincir Kızakları
Roller Chain Guides "UCD"

207 1TT

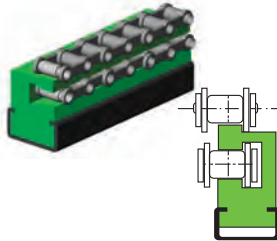

Alpolen 1 TT Model
Tipi Zincir Kızakları
Roller Chain Guides

206 CCZ

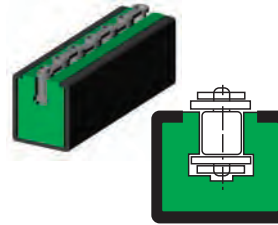

Alpolen CCZ Model Çelik
Profilli Zincir Kızakları
Roller Chain Guides

207 BL

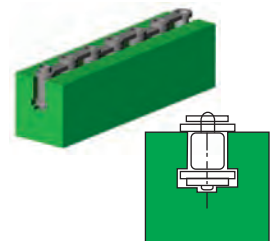

Alpolen 1000 BL
Model Zincir Kızakları
Roller Chain Guides

207 CUO

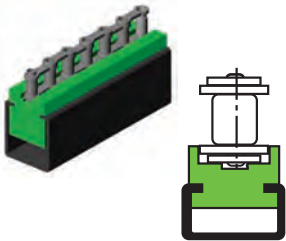

Alpolen 1000 U
Model Zincir Kızakları
Roller Chain Guides

207 OU0

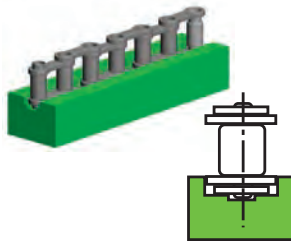

Alpolen 1000 U Zincir Kızakları
Roller Chain Guides

207 TU0



Alpolen 1000 U Düz Bantlar
için Çelik Profilli Zincir Kızakları
Straight Chain Guides

207 H15

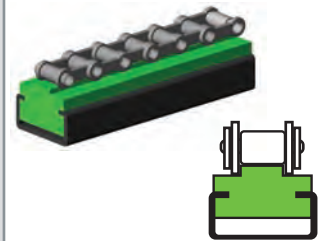

Alpolen 1000 T Model
Çelik Profilli Zincir Kızakları
Roller Chain Guides

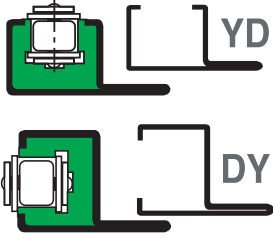
207 YD-DY

Alpolen 1000 Zincir Kızakları
Chain Guides

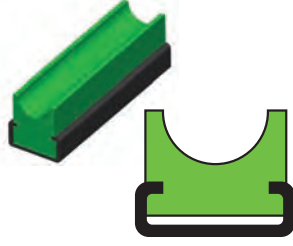
207 CCO

Alpolen 1000 Çelik
Profilli Kayış Kılavuzları
Cable and Belt Guides

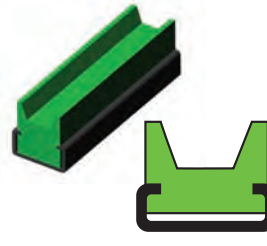
215 VCO

Alpolen 1000 Çelik
Profilli V Kayış Kılavuzları
Curves Track for 880 TAB-881 TAB Chains

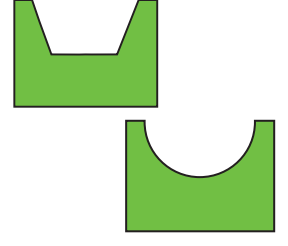
207 CTV

Alpolen 1000 (V) Kayış Kızakları
Link Chain Guides

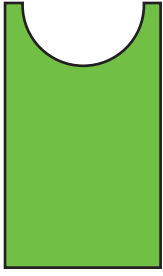
207 CTO

Alpolen 1000 Özel Kayış Kızakları
Belt Guides

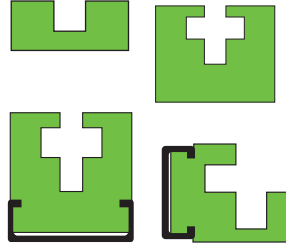
207 GH1

Alpolen 1000 Sıralı Zincir Kızakları
Belt Guides

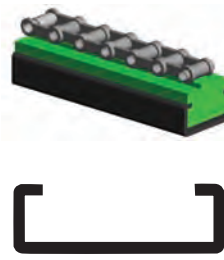
206 C02

Çelik Profiller
Steel Profiles

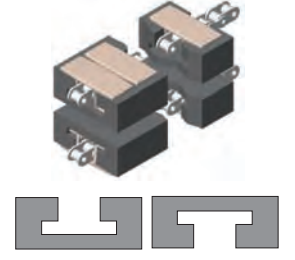
202 863

Doğrusal Yataklar 863 Serisi
Straight Track (for 863 series)

202 880

Alpolen 1000 Doğrusal Yatakları
Straight Track (for 880-881 series)

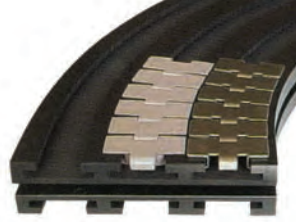
215 500

Alpolen 1000, 90° (880 Tab
881 Tab Dönüşlü Bantlar İçin)
Curves Track for 880 TAB-881 TAB chains

205 500

Alpolen 1000, 90° (880 Açılı
Kulaklı Bantlar İçin) Dönüş Yatakları
Curves Track (for 880 chains)

215 610

Alpolen 1000, 90° Dönüş Yatakları
(882 Tab Dönüşlü Ağır Tip Bantlar İçin)
Curves Track for 882 TAB chains/heavy duty)

225 500

Omurgalı (Kardenik)
Bant Dönüş Takımı
Curves Track for Cardanic Chains

220 KSK

Kasa Tasıma Bant Kızakları
Guides for Crate Chains

204 112

Yarasa Bant Dönüş Ünitesi
Curves Track for Bat Chains

221 873

Alpolen 1000, 90° Dönüş
Yatakları (1873 Bantlar İçin)
Curves Track (for 1873 series)

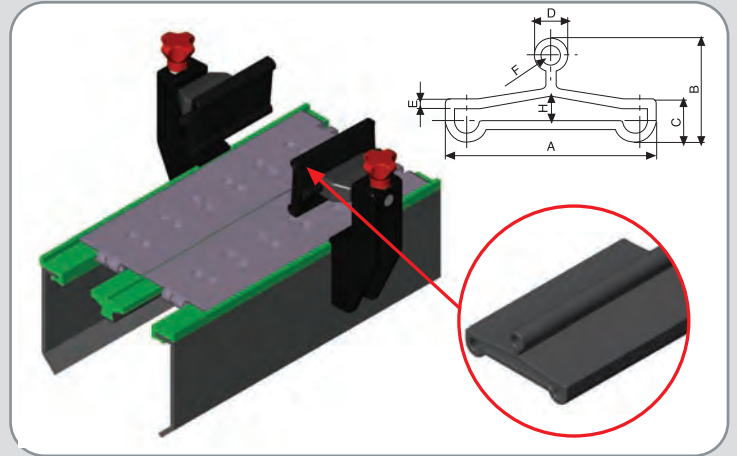
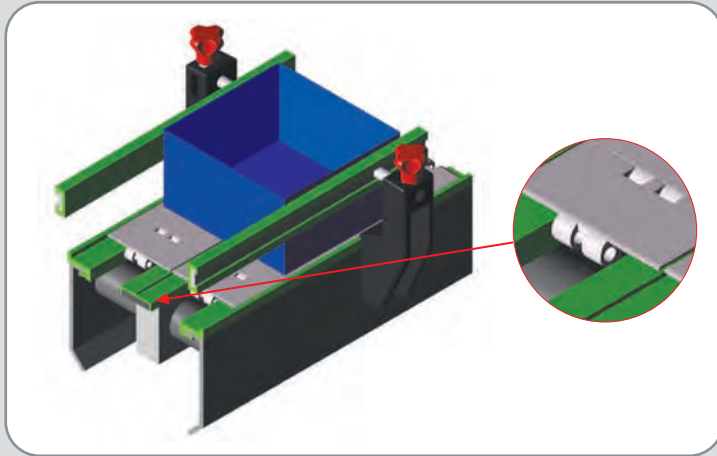
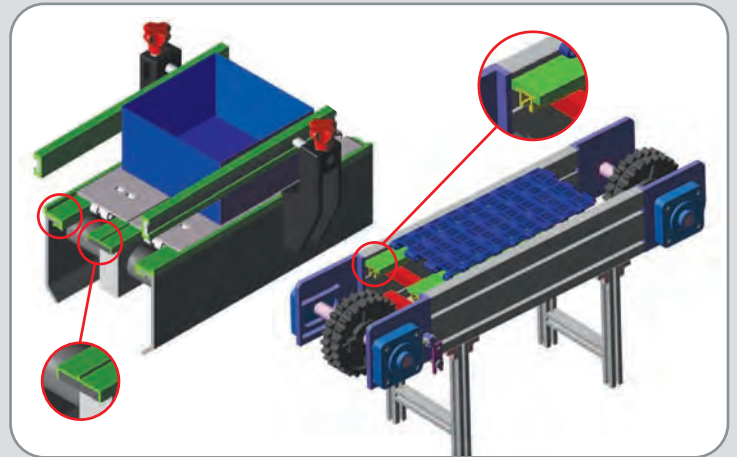
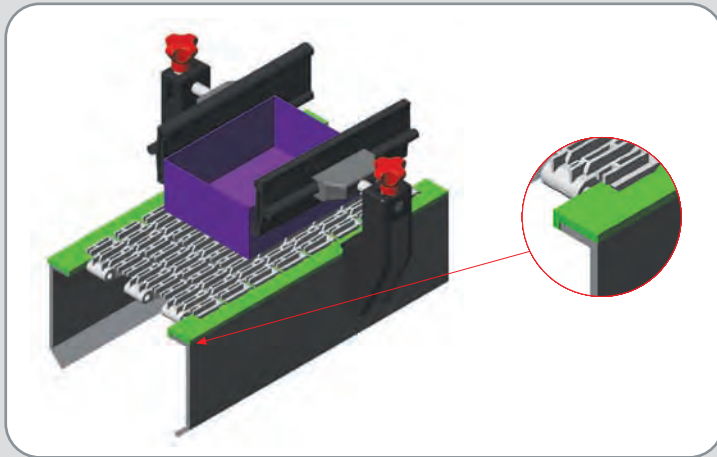
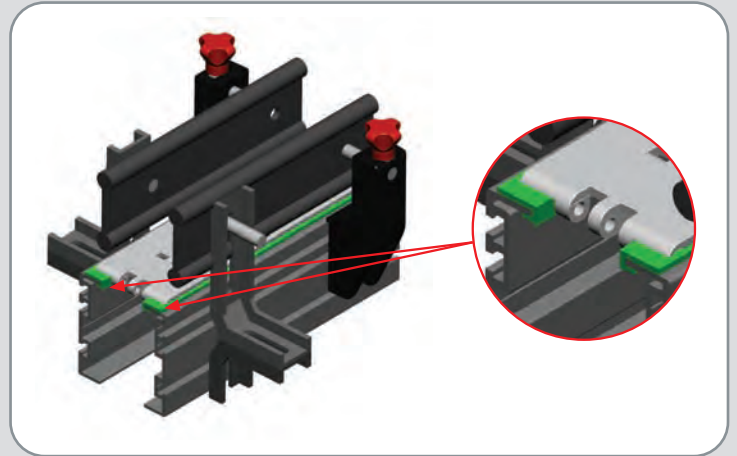
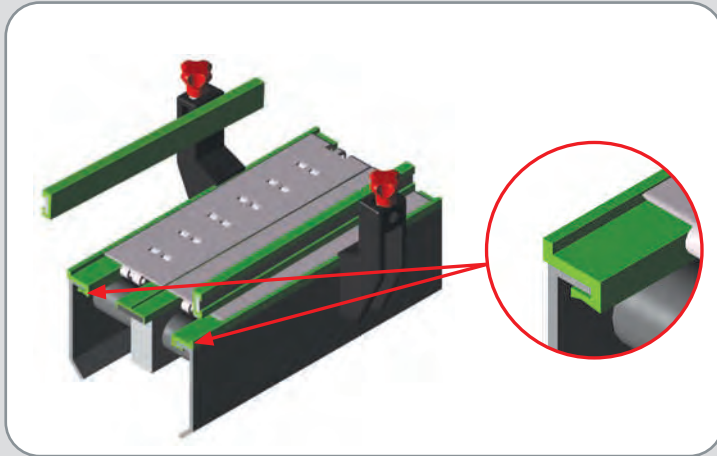
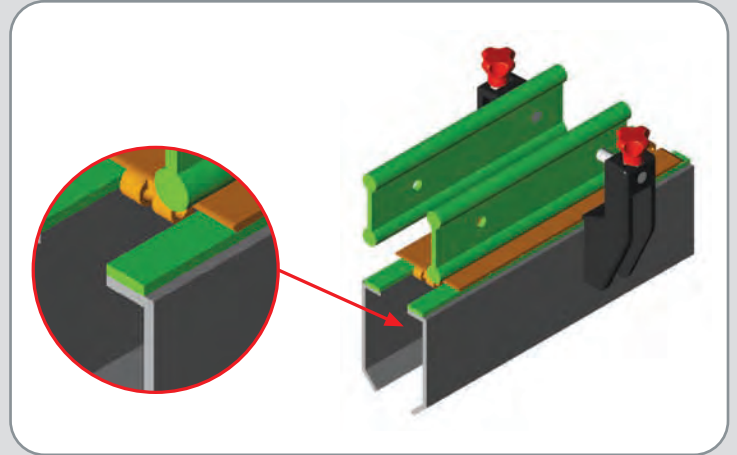
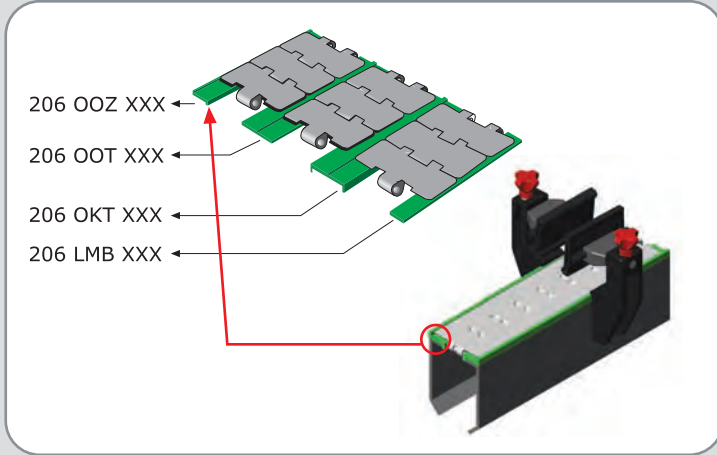

ÖZEL PROFİL UYGULAMALARI/SPECIAL PROFILES APPLICATIONS

M ALPOLEN® UHMW 1000

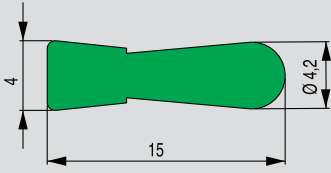

206 RGL 232

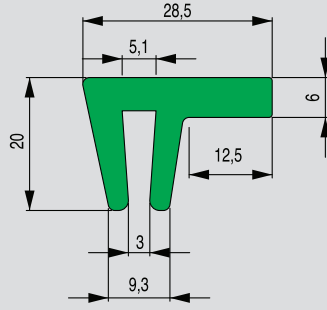

206 GZU 221

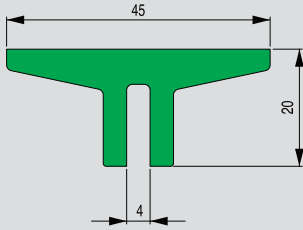
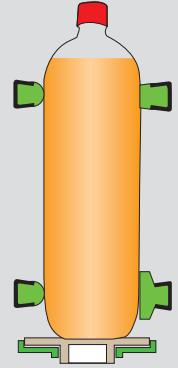
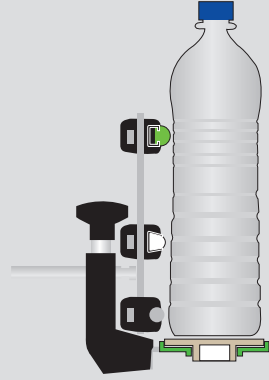

206 RGU 088

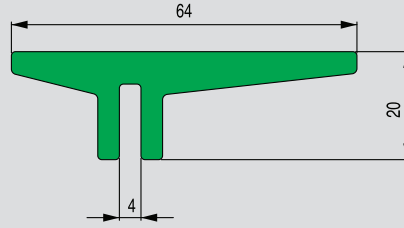

206 RGD 089

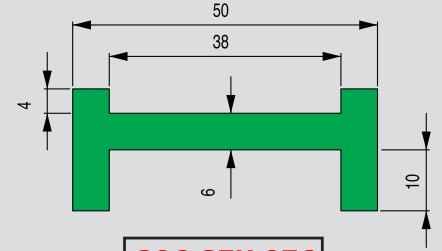

206 GZU 076

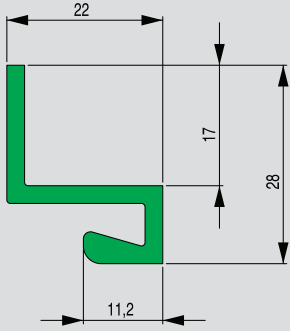

206 OGL 108

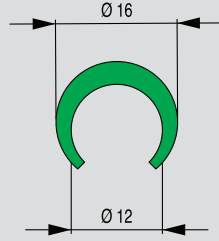

206 RGU 415

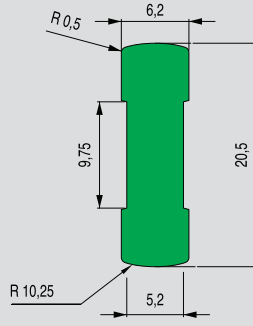

216 100 104

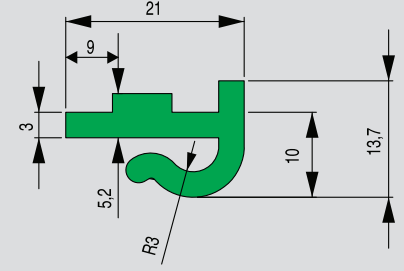

206 GLA 266

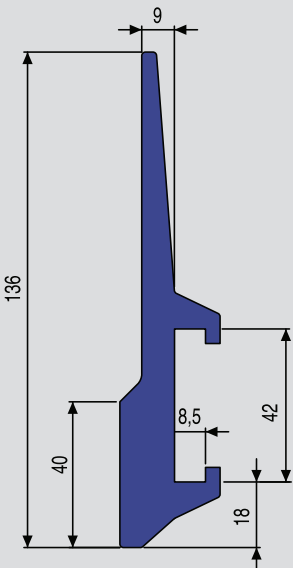

206 RGC 330

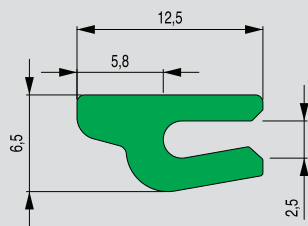

206 RGC 352

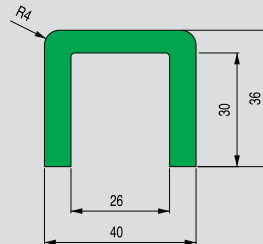

206 GZU 026

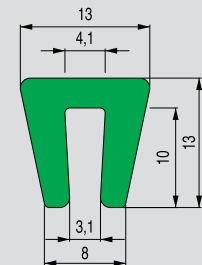

206 RGU 219

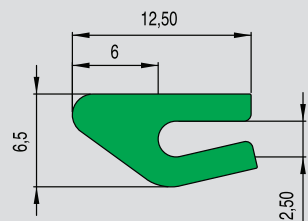

206 RGB 351

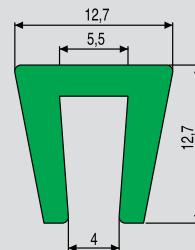

206 RGU 413

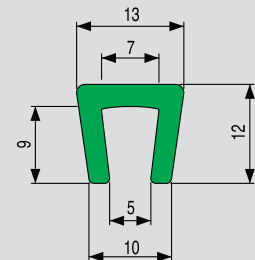

206 RGU 023



B SÜRTÜME PROFİLLERİ ve ZİNCİR KIZAKLARI FRICTION GUIDES & ROLLER CHAIN GUIDES

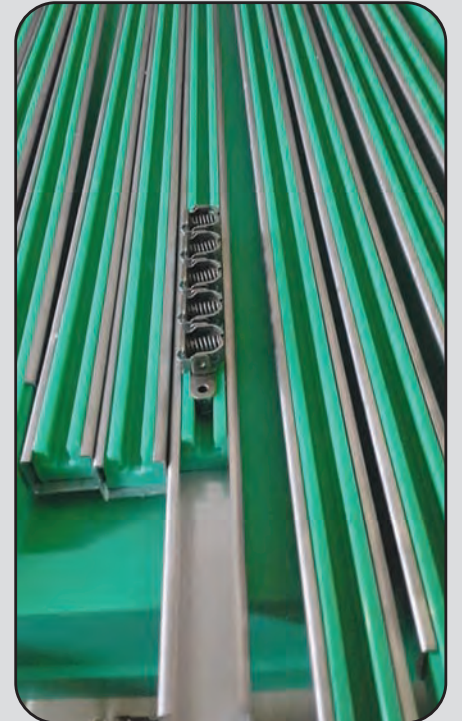
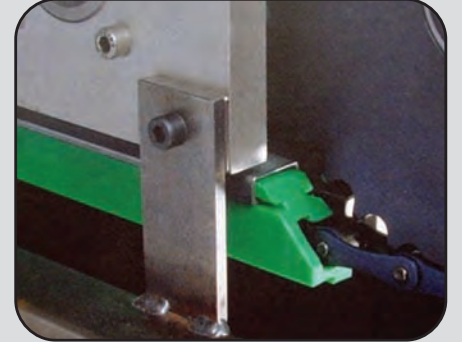
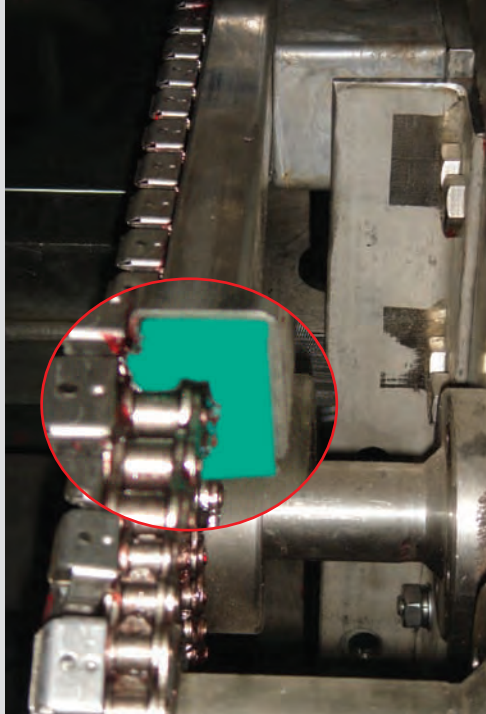
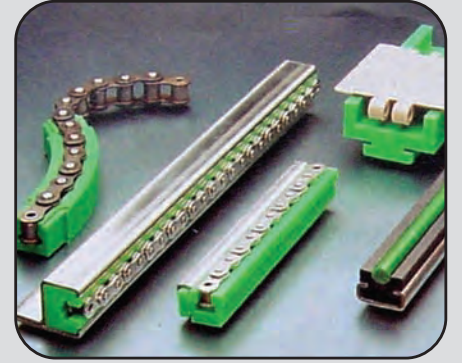
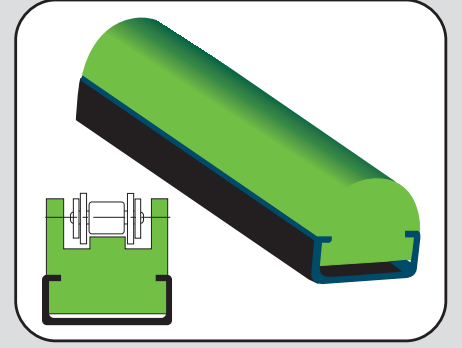
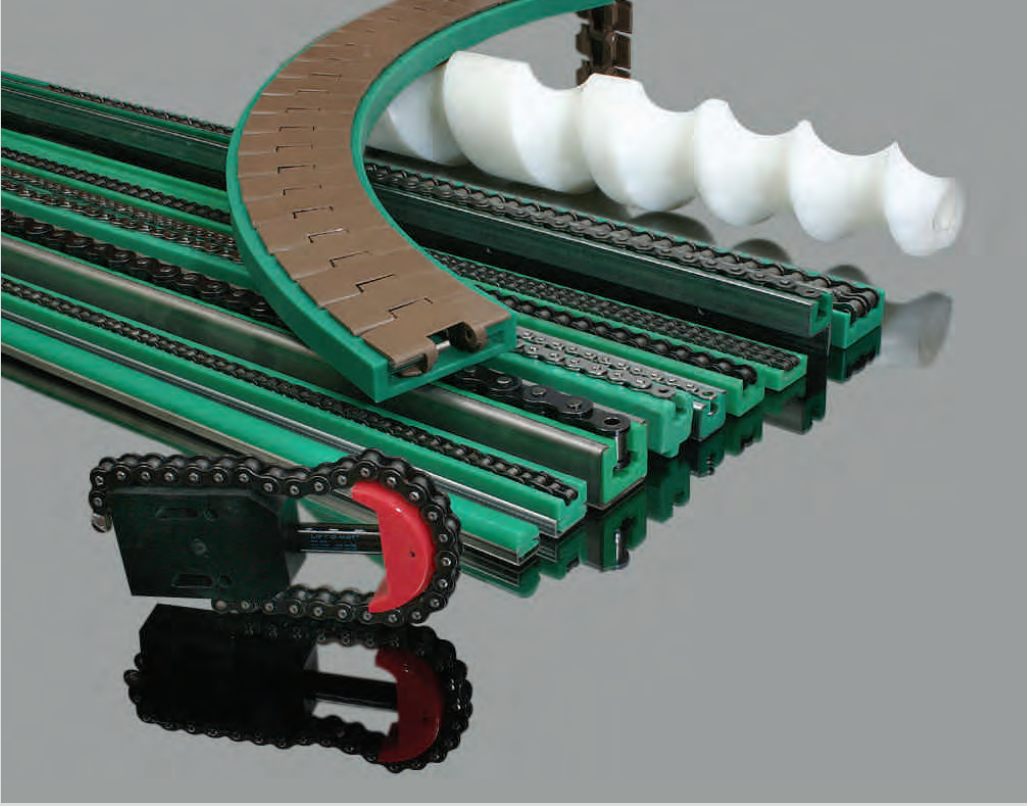

400



Sabit Plastik Pabuç (Metal Saplama)
Plastic Fixed Feet

515 - 510



Düz Taban Plastik Pabuç
(Metal Çinko Kaplama ve Paslanmaz)
Articulated Feet

620 - 621



Döküm Tabanlı ve
Milli Sabit Pabuç
Articulated Feet

502 - 530



Çinko Kaplamalı ve Paslanmaz
Ağır Tip Sabit Pabuçlar
Hard Type Articulated Feet (with snap ring)

610 -611



Döküm Tabanlı ve Mafsallı Pabuç
Spindle Articulated Feet

560



Çelik Paslanmaz Tabanlı
ve Milli Mafsallı Pabuç
Stainless Steel Base- Spindle Articulated Feet

605 - 606



Paslanmaz ve Metal Tabanlı
Sabitlenebilir Pabuç
Spindle Articulated Feet

521



Paslanmaz Sıvama Çelik
Tabanlı ve Milli Mafsallı Pabuç
Stainless Steel Base - Spindle (with rubber ring) Feet

520



Metal Sıvama Çelik
Tabanlı ve Milli Mafsallı Pabuç
Zinc Plated Steel Base Spindle (with rubber ring) Fix Feet

590



Paslanmaz Tabanlı
Sabit Milli Pabuç
Stainless Steel Base - Spindle (with snap ring) Fix Feet

580



Çinko Kaplamalı
Sabit Tabanlı Pabuç
Zinc Plated Steel Base - Spindle (with snap ring) Fix Feet

507



Çinko Kaplamalı Metal Tabanlı
ve Milli Mafsallı Pabuç
Zinc Plated Steel Base - Spindle (with snap ring) Fix Feet

500



Plastik Pabuç Tabanı
500 Plastic articulated base

510



Plastik Taban
510 Plastic articulated base

507-560



Mafsallı Metal ve Paslanmaz Taban
507-560 Steel Base

230



Kare Profil Klavuzları
Threaded Tube Ends (for square profile)

235



Yuvarlak Profil Klavuzları
Threaded Tube Ends

220 211 110



Plastik İki Ayak Açılı Boru ve Profil Bağlantılı
Bipop (Angled)

220 211 120



Plastik İki Ayak Açısız Boru Profil Bağlantılı
Bipop

220 211 130



Plastik Üçlü Ayak

240 021 200



Yan Bağlantı Takozu
Side Mounting Top Brackets

240 021 180



Gövde Bağlantı Takozu
Support Heads

240 021 170



Ara Bağlantı Takozu
Connecting Joint





ALHAN'ın
ayak gücü



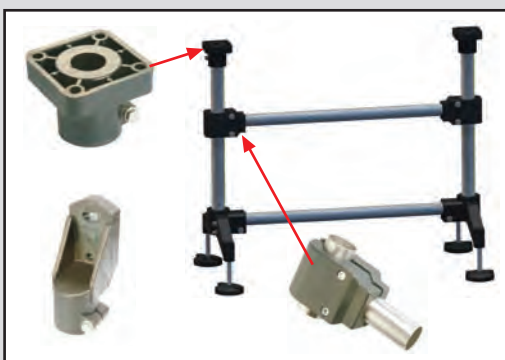

765 020 020

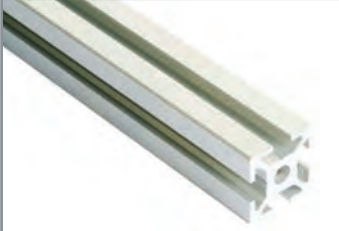

20x20 Alüminyum Sigma Profil
20X20 Silver Anodized Aluminium Profile

765 025 025

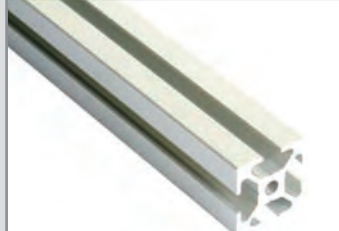

25x25 Alüminyum Sigma Profil
25X25 Silver Anodized Aluminium Profile

765 030 030

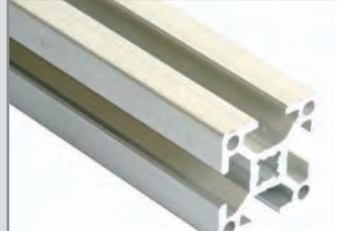

30x30 Alüminyum Sigma Profil
30X30 Silver Anodized Aluminium Profile

765 040 040

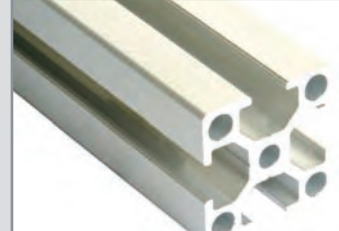

40x40 Alüminyum Sigma Profil
40X40 Silver Anodized Aluminium Profile

765 025 150

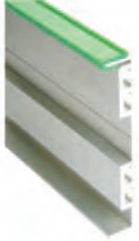

25x150 Konveyör Yan Şase
Alüminyum Sigma Profil
25X150 Silver Anodized Aluminium Profile

765 085 075

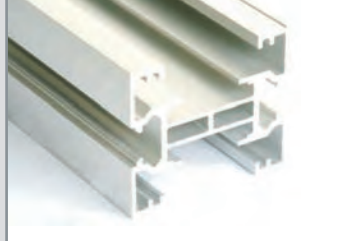

85x75 Alüminyum Sigma Profil
Düz Kulak Yarasa Bant için
85X75 Silver Anodized Aluminium Profile

766 085 075

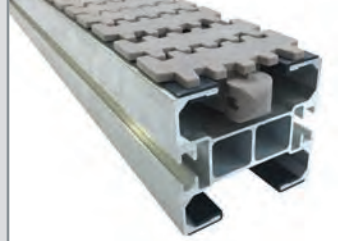

85x75 Alüminyum Sigma Profil
Silindir Kulak Yarasa Bant için
85X75 Silver Anodized Aluminium Profile

765 045 045

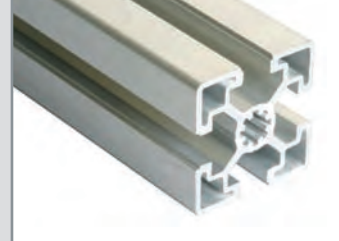

45x45 Alüminyum Sigma Profil
45X45 Silver Anodized Aluminium Profile

765 050 050

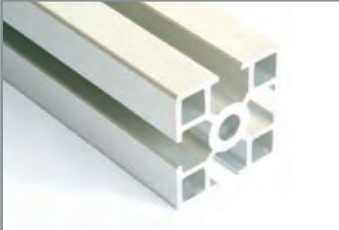

50x50 Alüminyum Sigma Profil
50X50 Silver Anodized Aluminium Profile

765 023 129

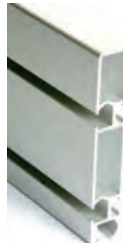

23x129 Konveyör Yan Şase
Alüminyum Sigma Profil
23x129 Structural Silver Anodized Aluminium Profile

765 025 105



25x105 Konveyör Yan Şase
Alüminyum Sigma Profil
25X105 Structural Silver Anodized Aluminium Profile

765 025 115



25x115 Konveyör Yan Şase
Alüminyum Sigma Profil
25X115 Structural Silver Anodized Aluminium Profile

765 106 120



106X120 Alüminyum Sigma
Profil Montaj Hattı İçin
106X120 Assembly Line Aluminium Profile

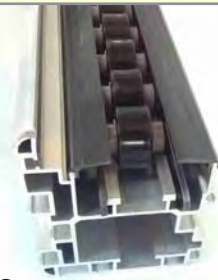

765 000 002



766 016 033

766 011



Baklava Dilimli Kanal Somunu
Nut For Sigma Profile

206 APC 040



40 mm C Profil
İçin Alüminyum Profil
Silver Anodized Aluminium Profile For Guides

206 AGC 040

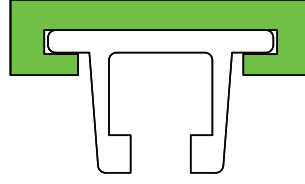

40 mm C Profil Alpolen®
+ Alüminyum Profil
Alpolen® 1000

265 BSC 040

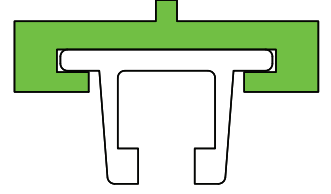

T Alpolen®
+ Alüminyum Profil
Alpolen® 1000

765 050 088

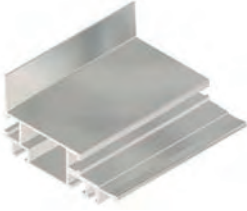

50x88 Konveyör Yan Şase
Alüminyum Sigma Profil
50X88 Structural Silver Anodized Aluminium Profile

765 025 117

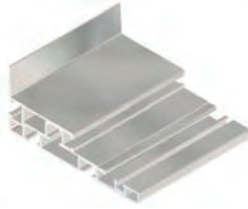

50x118 Konveyör Yan Şase
Alüminyum Sigma Profil
50X118 Structural Silver Anodized Aluminium Profile

765 045 165



45x165 Alüminyum Sigma Profil
45X165 Structural Silver Anodized Aluminium Profile

765 040 080



40x80 Köşe Bağlantı
Alüminyum Sigma Profil
40X80 Silver Anodized Aluminium Profile

765 045 090



45x90 Alüminyum Sigma Profil
45X90 Silver Anodized Aluminium Profile

766 013 070



Bayrak Köşe Bağlantı (75x75)
Corner Connection (75X75)

766 013 111



Bayrak Köşe Bağlantı (110x110)
Corner Connection (110X110)

766 013 145



110x110 Bayrak T
Bağlantı Açısı Ayarlı
"T" Flat Connection (110X110)

766 013 112



110x110 Bayrak
T Bağlantı
"T" Flat Connection (Angled)

766 012 012



Köşe Bağlantı 90° (Üst-Alt)
Simple Side Attachment

766 011 011



Köşe Bağlantı 90° (Sağ-Sol)
Simple Front Attachment

766 011 001



Alüminyum Profil Çekirme Pimi
Aluminium Profile Draw-PIN

766 015

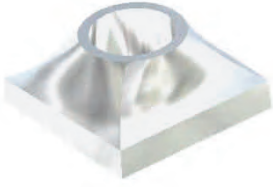

Kare Kanal Somunları
Nut

766 010



Yaylı Somunlar
Arc Nut

766 018 002



23x129 Alüminyum
Germe Plakası Takımı
(23X129) Aluminium Profile Stretcher Plate Set

766 018 001



23x129 Alüminyum
Tahrik Plakası Takımı
(23X129) Aluminium Profile Support for
Axis and Bearing Plate Set

766 018 003



25x150 Alüminyum
Germe Plakası Takımı
(25X150) Aluminium Profile Support for
Axis and Bearing Plate Set

766 018 004



25x150 Alüminyum Tahrik Plakası
(25X150) Aluminium Profile Support for
Axis and Bearing Plate Set

766 018 007



45x45 Alüminyum Profil
Tahrik Plakası Takımı
(45X45) Aluminium Profile Support for
Axis and Bearing Plate (Right-Left)

766 018 008



45x45 Alüminyum Profil Avare
Plakası Takımı (Sağ Ve Sol)
(45X45) Aluminium Profile Support for
Axis and Bearing Plate (Right-Left)

760 018 009

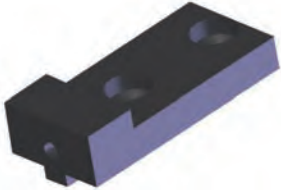

45x45 Alüminyum Profil Avare
Gerdirme Aparatı Takımı
(45X45) Aluminium Profile Support for
Axis and Bearing Plate

766 019 009



45x90 Alüminyum Avare
Plakası Takımı (Sağ Sol)
(45x90) Aluminium Stretcher Plate (Right-Left)

766 019 010



45x90 Alüminyum Tahrik
Plakası Takımı (Sağ Sol)
(45X90) Aluminium Profile Support
for Axis and Bearing Plate

766 019 011



45x90 Alüminyum Profil Avare
Gerdirme Aparatı Takımı
(45X90) Aluminium Profile Support for Axis

766 016 001

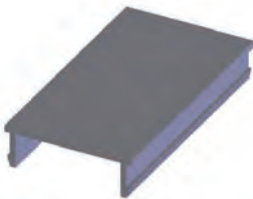

Alüminyum Profil Kanal Fitili (8)
Aluminium Strip Profile (8)

766 016 002

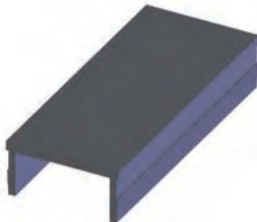

Alüminyum Profil Kanal Fitili (10)
Aluminium Strip Profile (10)

766 016 003

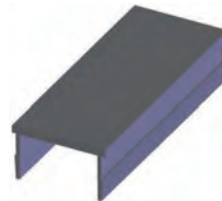

Alüminyum Profil Kanal Fitili (10)
Aluminium Strip Profile (10)

766 311



Plastik Köşe Bağlantı 45x45
Side Connection (Plastic)

766 014 020



20x20 Plastik Profil Kapağı
20X20 Plastic Profile Cover

766 014 025



25x25 Plastik Profil Kapağı
25X25 Plastic Profile Cover

766 014 590



45x90 Plastik Profil Kapağı
45X90 Aluminium Profile Cover

766 RUT

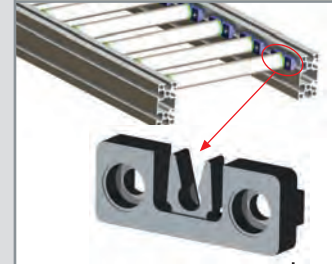

Rulolu Koverörler İçin
Rulo Tutucu
Roll Holder For Roller Conveyor

766 SBP



Sigma Profil Ayak
İçin Plastik Bağlantı
Side Support

766 011 003



Zamak Köşe Bağlantı 30x30
30X30 Brackets

765 111

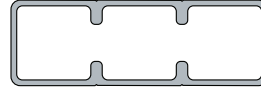

90x30 Alüminyum Sigma Profil
90x30 Aluminium profile

765 222

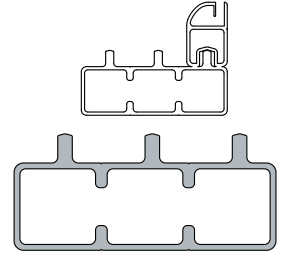

90x30 Alüminyum Sigma Profil
90x30 Aluminium profile

765 333

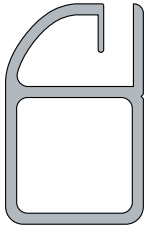

40x25 Alüminyum Sigma Profil
40x25 Aluminium profile

765 444

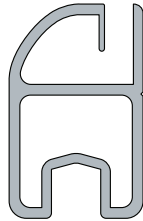

40x25 Alüminyum Sigma Profil
40x25 Aluminium profile

765 555

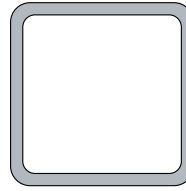

30x30 Alüminyum Sigma Profil
30x30 Aluminium profile



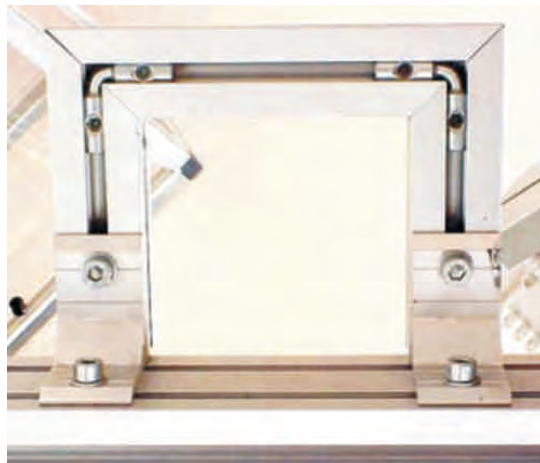
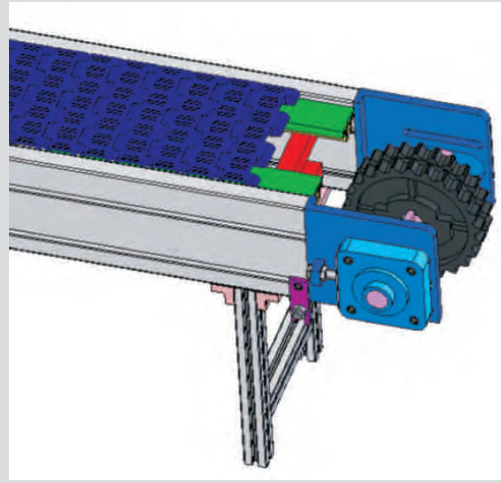
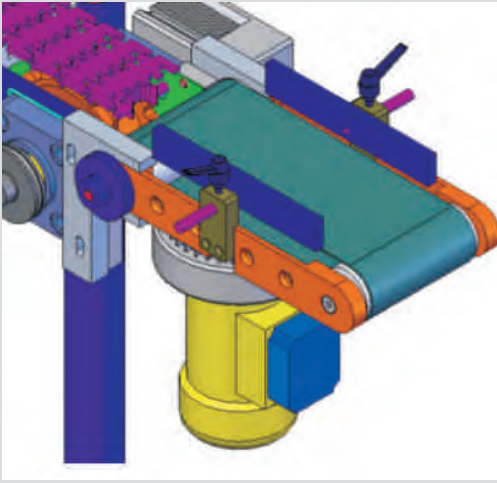
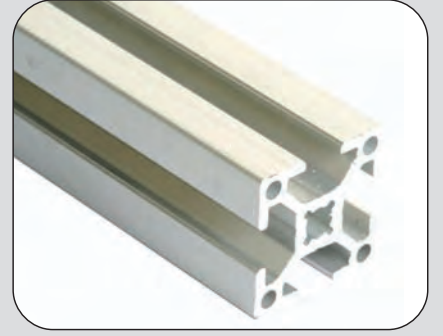
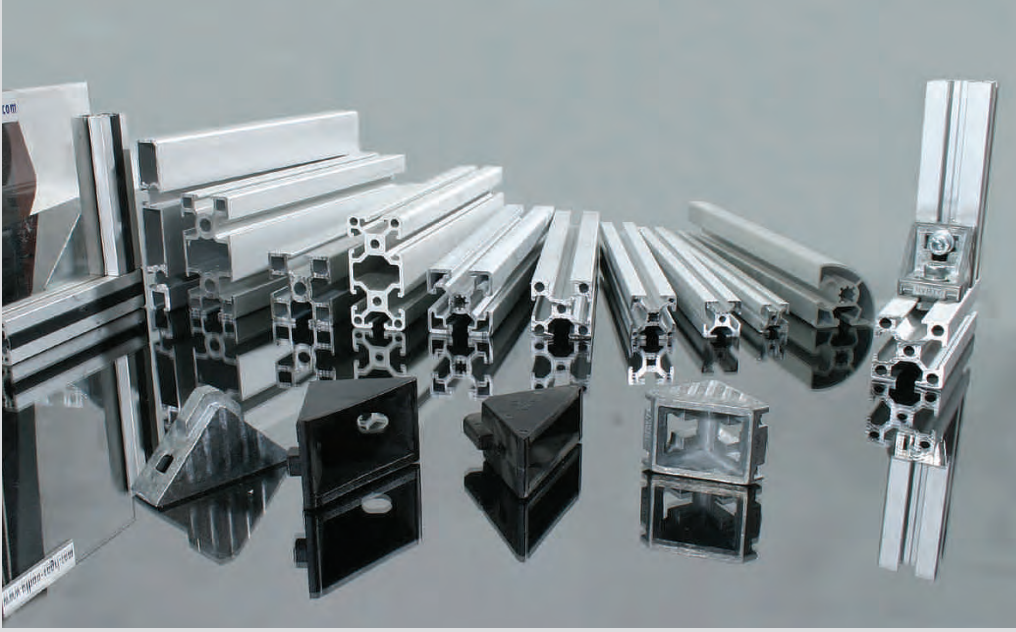

210 IBB



Dar Balık Sırtı Profil
Tekli Mengene (Milli)
Single Clamp with Rod

210 DTY M...



Dar Sırtlı Mengene (Milli)
Single Clamp with Rod

211 60P MLL



60 mm Pvc Profil
için Mengene (Milli)
Single Clamp with Rod

210 DTT M...



Dar Tekli Mengene (Milli)
Single Clamp with Rod

210 010 161



Konsol Mengene Takımı
(İkili-Milli)
Clamps for Round Profile Guides (with Pin)

210 DTY A04



Balık Sırtı Profil için
Geniş Mengene (Milli)
Single Clamp with Rod

800 240



Balık Sırtı Profil için
Geniş Mengene (Milli)
Single Clamp with Rod

210 GTT



Geniş Tutucu Tekli
Mengenesi (Milli)
Guide Rail Clamp with Rod

210 DTT



Dar Tekli Mengene (Milsiz)
Single Clamp

211 IBB 000

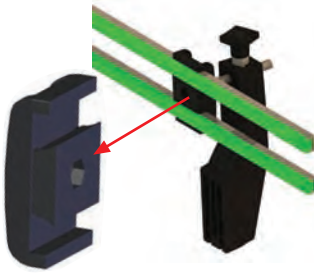

Balık Sırtı Profil İki Mengene
Double Clamp with Rod

211 60P



60 mm PVC Kenar Dayama Profili
Single Clamp

210 IIB



Balık Sırtı Profil Dar Tekli Mengene
Single Clamp with Profile

210 DTY



Dar Sırtlı Tekli Mengene
Single Clamp with Profile

210 GTT



Geniş Tutucu Tekli Çubuk Mengenesi
Guide Rail Clamps

800 210 134



Balık Sırtı Profil Geniş
Mengene Kapalı Tip
Single Clamp

800 210 133



Balık Sırtı Profil Geniş
Açık Tip Mengene
Single Clamp

FBL



FBL Rulman Yatakları
Omega Bearing Insert

PPL



PPL Rulman Yatakları (Köprü)
Omega Bearing Insert

TBL



TBL Rulman Yatakları
Omega Bearing Insert

NFL



NFL Rulman
Yatakları (Badem)
Omega Bearing Insert

FPL



FPL Rulman
Yatakları (Kare)
Omega Bearing Insert

TPL



TPL Rulman
Yatakları (Gergi)
Omega Bearing Insert

HPL



HPL Rulman Yatakları
Omega Bearing Insert

CFL



CFL Rulman
Yatakları (Badem)
Omega Bearing Insert

KFL



KFL Rulman
Yatakları (Badem)
206 Bearing Unit

UCF



UCF Rulman
Yatakları (Kare)
Omega Bearing Insert

KAP



Rulman Yatak Kapağı
Closed Cover

214 151



Fotosel Çapraz Tutucu Mengenesi
Cross Block for guides

214 152 010-012



Fotosel Gövde
Bağlama Mengenesi
Photocell Cross Block

214 1 530 010-012



Fotosel Tutma Mengenesi
Photocell Clamp

214 IFM 000

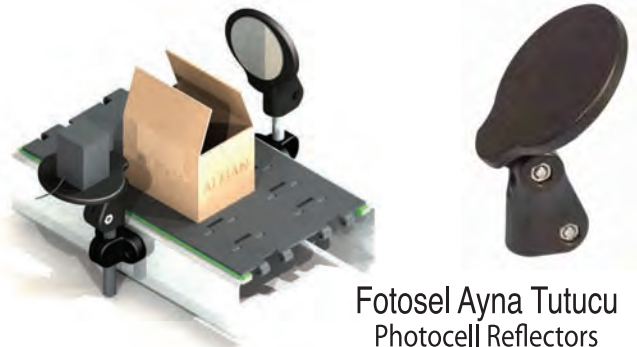

Fotosel Ayna Tutucu
Photocell Reflectors

210 410 200



Konsol Gövdesi (Küçük Boy)
Adjustable Brackets

210 010 200



Konsol Gövdesi (Orta Boy)
Adjustable Brackets

210 010 201



Konsol Gövdesi (Büyük Boy)
Adjustable Brackets

210 410 100



Orta Boy Konsol Tabanı
Support Spacer

210 100 100

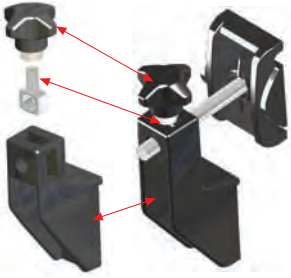

Konsol Tam Takım (Küçük Boy)
Adjustable Brackets

210 100 200



Konsol Tam Takım (Orta Boy)
Adjustable Brackets

210 100 300



Konsol Tam Takımı (Büyük Boy)
Adjustable Brackets

215 000 101



Plastik Mentеше 49x65
Hinges

215 000 104



Plastik Mentеше 49x49
(Somunlu)
Hinges

215 000 102



Plastik Mentеше 78x100
78X100 Hinges

215 SZA



40X40, 50X50, 60X60
Zamak Mentеше
40X40, 50X50, 60X60 Hinges

215 000 103



Plastik Mentеше Vidalı 49x49
49X49 Hinges

210 D10 024



Dişi Tutgaçlar
Knobs

210 E10 025



Erkek Tutgaçlar
Knobs

210 222 100



Yüksük
Eyebolt for Knob

210 122 100



Plastik Yüksük
Eyebolt for Knob

261 504 532



Avare Rulo Başlığı
Idle rollers

271 434



Avare Rulo Başlığı
Idle rollers

795 025 070



Rulmanlı Rulo Başlığı
Bushing Rollers Heads

758 000 PAG



Su Fiskiyesi
Nozzle

210 IDT 200



Dönürlü Konsol Gövde
Adjustable Brackets

216 SKA 000



Sürgülü Kilit
Spring Lock

767 000 004



Çerçeve Cam Tutucu
Panel Clamp

753 050 030



50x30 Kablo Tasıma Kanalı
Cable chains

216 100 001



Profil Tarağı
Chain Return Components

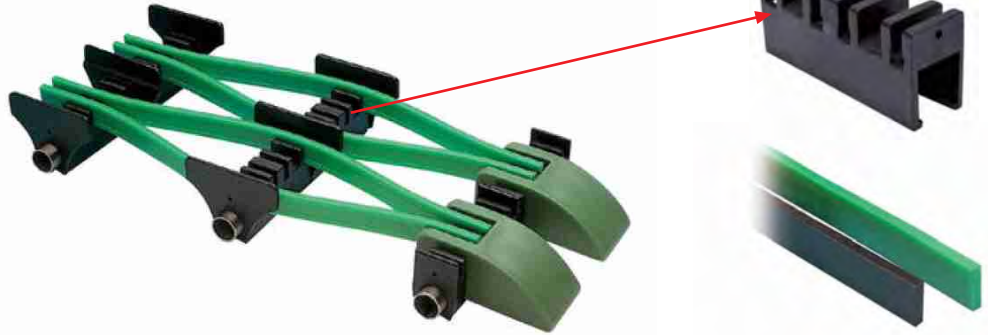

800 411 660



Boncuk Makara 4 Sıralı
Roller Guide (Four roller design)

800 414 657



Boncuk Makara 3 Sıralı
Roller guide (three roller desing)

800 411 654



Boncuk Makara 2 Sıralı
Roller guide (three roller desing)



241 200



Dönüslü Dişi Kol
Adjustable hanle

241 100



Dönüslü Erkek Kol
Adjustable hanle

689 000

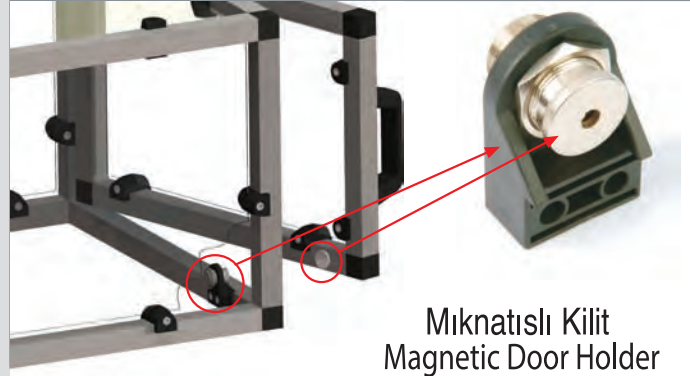

Mıknatıslı Kilit
Magnetic Door Holder

764 EKS 001



Kapama Sistemleri
Frame systems

764 CKS 001



Kapama Sistemleri
Frame systems

764 BKS 001



Kapama Sistemleri
Frame systems

764 AKS 001



Kapama Sistemleri
Frame systems

764 FKS 001



Kapama Sistemleri
Frame systems

764



Kapama Sistemleri
Frame systems

764 GKS 001



Kapama Sistemleri
Frame systems

252 000



Bakalit Kapak Kolu
Handles

252 710



Plastik Kapak Kolu
Handles

252 620



Plastik Kapak Kolu
Handles

215 UKK



Uzun Kapak Kolu
Handles

KTR



Plastik Rulo Başlığı Ø16
Bearings Ø16

KTR



Plastik Rulo Başlığı Ø30
Bearings Ø30

KTR



Plastik Rulo Başlığı Ø20
Bearings Ø20

KTR



Plastik Rulo Başlığı Ø40
Bearings Ø40

KTR



Plastik Rulo Başlığı Ø50
Bearings Ø50

MKR



Plastik Tekerlek
Plastic Wheel

MTR



Metal Rulo Başlığı Ø20
MTR Bearing Ø20

MTR



Metal Rulo Başlığı Ø30
MTR Bearing Ø30

MTR



Metal Rulo Başlığı Ø40
MTR Bearing Ø40

MTR



Metal Rulo Başlığı Ø50
MTR Bearing Ø50

MTR



Metal Rulo Başlığı Ø60
MTR Bearing Ø60

MTR



Metal Rulo Başlığı Ø60
MTR Bearing Ø60



DSH



Volan Tutgaç
Handwheels

VM



Volan Tutgaç
Handwheels

VP



Volan Tutgaç
Handwheels

VR



Volan Tutgaç
Handwheels

215

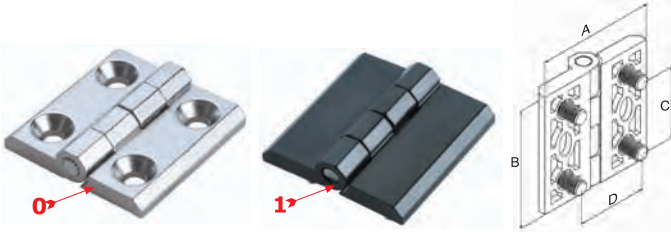

Yaprak Menteşe
Leaf Hinges

800 411

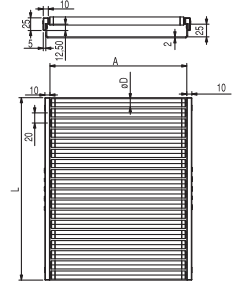

Ø16'lik Makara Rulolu Kılavuz
Roller Guide

215 ICB



Dönüş Konsol Başlığı
Heads Type

700 640

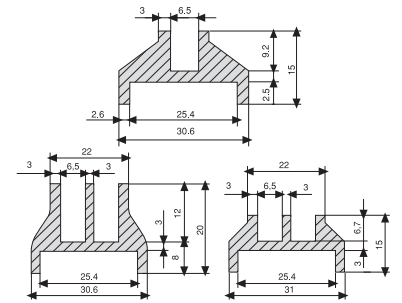

Açılır Çerçeve Profilleri
Runner Profiles

700 640



Çerçeve Sabitleyici
Stop for Hinged Doors

Alhan Rulman Yatakları

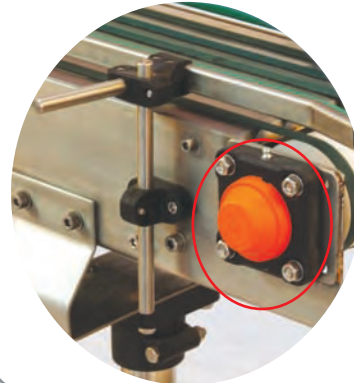

GP40A



Makaralı Ray
Roller Guide

GP40C



Makaralı Ray
Roller Guide

GR40



Makaralı Ray
Roller Guide

GR60



Makaralı Ray
Roller Guide

GP60S

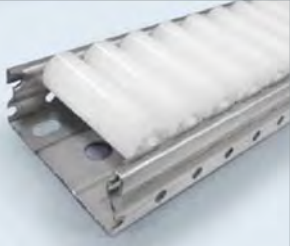

Makaralı Ray
Roller Guide

GP60B

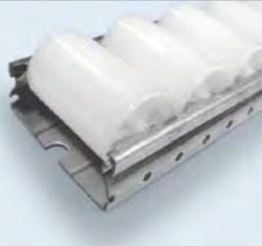

Makaralı Ray
Roller Guide

GP60A

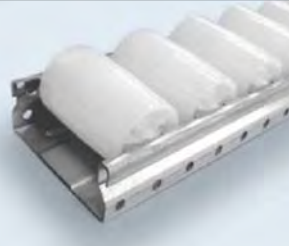

Makaralı Ray
Roller Guide

GP70



Makaralı Ray
Roller Guide

GP70B



Makaralı Ray
Roller Guide

GR70B



Makaralı Ray
Roller Guide

Hedef
"Yalın" üretim

Goal
"Lean" manufacturing

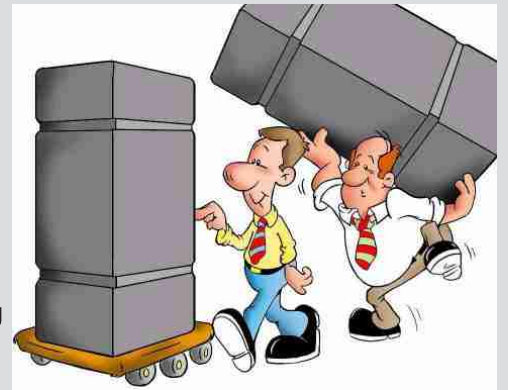

GR70



Makaralı Ray
Roller Guide

GR85

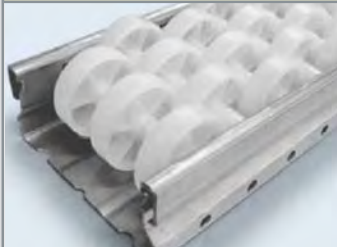

Makaralı Ray
Roller Guide







ÇAĞRI[®]
ENDÜSTRİ A.Ş.

ALHAN[®]

- ÜRETİMDEN SATIŞ
- FROM PRODUCTION TO SALES

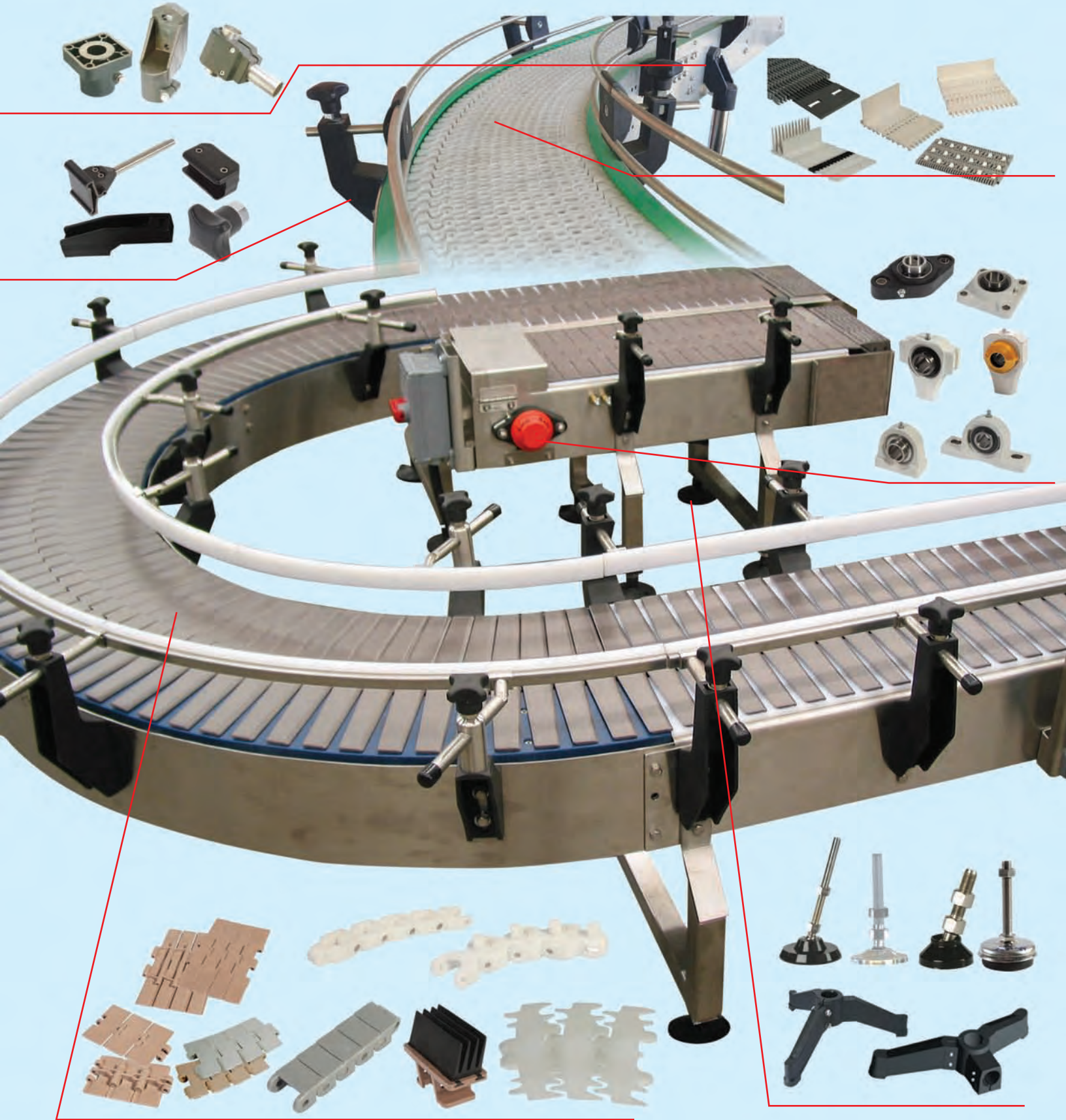

Kimyasal Dirençler Chemical Resistance Temperatures up to 65°C 65°C'ye Kadar	Polyamid Polyamide	Çelik Steel	Paslanmaz Çelik Stainless Steel AISI 304	Paslanmaz Çelik Stainless Steel AISI 430	Düşük Sürtümlü Asetal LF Acetal (POM)	ALPOLEN® 1000 UHMW	Polipropilen Polypropylene (PP)
Aseton Acetone	+	-	+	+	+	+	+
Asedik Asit Acetic Acid (max.5%)	-	-	+	-	-	+	+
Sitrik Asit Citric Acid	0	-	+	0	0	+	0
Formik Asit Formic Acid	-	+	+	+	-	+	+
Fosforik Asit Phosphoric Acid (max.10%)	-	-	+	-	-	+	+
Hidroklorik Asit Hydrochloric Acid (max.2%)	-	-	-	-	-	+	+
Laktik Asit Lactic Acid	+	-	+	-	+	+	+
Nitrik Asit Nitric Acid	-	-	+	0	-	0	+
Sülfid Asit Sulphide Acid	-	-	-	-	-	-	+
Yağ Oil (vegetable or mineral)	+	+	0	+	+	+	+
Sabun Soap and water	+	0	+	+	+	+	+
Tatlı Su Water	+	-	+	+	+	+	+
Deniz Suyu Sea water	-	0	+	0	+	+	+
Alkol Alcohol	+	+	+	+	+	+	+
Amonyak Ammonia	+	0	+	+	-	+	+
Alkolsüz İçki Soft drinks	+	+	+	+	+	+	+
İspirto Spirits	+	+	+	+	+	+	+
Benzen Benzene	+	+	+	+	+	0	-
Benzol Benzol	+	+	+	+	+	+	0
Bira Beer	+	+	+	+	+	+	+
Çikolata Chocolate	0	+	+	+	0	0	+
Sodyum Hidroklorid Sodium Hydrochloride	+	-	0	-	+	+	+
Petrol Petrol	+	+	+	+	+	0	+

Kimyasal Dirençler Chemical Resistance Temperatures up to 65°C 65°C'ye Kadar	Polyamid Polyamide	Çelik Steel	Paslanmaz Çelik Stainless Steel AISI 304	Paslanmaz Çelik Stainless Steel AISI 430	Düşük Sürtümlü Asetal LF Acetal (POM)	ALPOLEN® 1000 UHMW	Polipropilen Polypropylene (PP)
Sodyum Hidroksid Sodium hydroxide (max.25%)	+	-	+	+	-	+	+
Sodyum Hipoklorid Sodium hypochlorite	+	-	-	-	-	+	+
Meyve Suyu Fruit Juices	+	-	+	0	+	+	+
Sebze Suyu Juices vegetable	+	0	+	+	+	+	+
Süt Milk	+	+	+	+	+	+	+
Hardal Mustard	0	+	+	+	+	0	+
Parafin Paraffin	+	+	+	+	+	+	0
Hidrojen Peroksit Hydrogen peroxide	-	-	+	0	-	0	+
Karbon Tetraklorid Carbon tetrachloride	+	0	0	0	+	0	-
Toluene	-	-	-	-	+	0	+
Turpentin Turpentine	-	+	+	+	-	0	+
Sirke Vinegar	+	-	0	-	+	+	+
Şarap Wine	+	+	+	+	+	+	+
Viski Whisky	+	+	+	+	+	+	+
Lodine	-	0	0	0	0	0	0
Xilol	-	-	-	-	-	-	-

+ = İyi / Good

0 = Orta / Average

- = Yetersiz / Unsatisfactory

Yukarıda belirtilen değerler firma tecrübesine dayalı olup garanti niteliği taşımamaktadır.

Malzemeler ve ürünler çalışma şartları doğrultusunda test edilerek uygun koşullar saptanmalıdır.

Ürünlerimizin Mekanik Analizleri SOLID WORKS Programında yapılmaktadır.

This information may be considered as a basis for recommendation, but not as a guarantee.

Materials and products should be tested under exact intended service conditions

to determine their suitability for a particular purpose.

Mechanical Analysis of products on SOLID WORKS

MALZEME UYGUNLUK KODU MATERIAL SUITABILITY CODE

- R = Tavsiye edilir/Recommended**
NR = Tasviye Edilmez/Not Recommended
Q = Kuşkulu/Questionable
— = Bilgi Mevcut değil/No Available Information

KİMYASALIN ADI CHEMICAL NAME	STANDART MALZEMELER/STANDARD MATERIALS							
	PP		PE		POM		PP <small>Isıya Dayanıklı</small> Heat Resistant	
	(21 °C)	(60 °C)	(21 °C)	(60 °C)	(21 °C)	(60 °C)	(21 °C)	(60 °C)
Asetik Asit / Acetic Acid	R	R	R	Q	—	—	NR	NR
Acetic Acid - %5 /Asetik Asit - % 5	R	R	R	R	R	—	NR	NR
Aseton / Acetone	R	R	R	R	Q	Q	R	R
Alcehol - Tüm Türleri / Alcehol - All Types	R	R	R	R	—	—	R	R
Şap - Tüm Türleri / Alum - All Types	R	R	R	R	—	—	—	Q
Alüminyum Bileşikler / Aluminum Compounds	R	R	R	R	—	—	R	R
Amonyak / Ammonia	R	R	R	R	—	—	R	R
Amonyum Bileşikleri / Ammonium Compounds	R	R	R	R	—	—	R	Q
Amonyum Bileşikleri / Ammyl Acetate	Q	NR	Q	NR	—	—	N	R
Ammyl Klorür / Ammyl Chloride	NR	NR	Q	NR	—	—	—	—
Anilin / Aniline	R	R	R	NR	—	Q	—	Q
Aqua Regia / Aqua Regia	NR	NR	Q	NR	—	—	NR	—
Arsenik Asit / Arsenic Acid	R	R	R	R	—	—	—	—
Baryum Bileşikleri / Barium Compounds	R	R	R	R	—	—	R	R
Baryum Sabun Gres / Barium Soap Grease	R	Q	—	—	—	—	—	—
Bira / Beer	R	R	R	R	—	—	—	R
Benzen / Benzene	Q	NR	Q	NR	R	Q	R	R
Benzenesulfonic Asit -% 10 / Benzenesulfonic Acid - %10	R	R	R	R	—	—	—	R
Benzoik Asit / Benzoic Acid	R	R	R	R	—	—	Q	R
Boraks / Borax	R	R	R	R	—	—	—	—
Borik Asit / Boric Acid	R	R	R	R	—	—	R	Q
Fren Sıvısı / Brake Fluid	R	R	—	—	R	R	R	R
Salamura -% 10 / Brine - %10	R	R	R	R	R	R	—	—
Bromik Asit / Bromic Acid	NR	NR	NR	NR	—	—	NR	—
Brom - Duman Sıvı / Bromine - Liquid of Fumes	NR	NR	NR	NR	—	—	NR	—
Brom Su / Bromine Water	NR	NR	Q	NR	—	—	R	R
Bütül Asetat / Butyl Acetate	NR	NR	R	Q	—	—	—	—
Bütül Akrilat / Butyl Acrylate	R	—	R	Q	—	—	Q	R
Butirik Asit / Butyric Acid	R	R	R	R	—	—	Q	—
Kalsiyum Bileşikleri / Calcium Compounds	R	Q	—	—	—	—	—	—
Kalsiyum Sabun Gres / Calcium Soap Grease	R	R	—	—	R	R	—	—
Calgonite -% 0.3 / Calgonite - 0.3%	R	R	R	R	—	—	R	R
Karbondioksit / Carbon Dioxide	Q	NR	Q	NR	—	—	R	R
Karbon Disülfid / Carbon Disulfide	NR	NR	NR	NR	R	Q	R	R
Karbon Tetraklorür / Carbon Tetrachloride	R	R	—	—	—	—	—	—
Cellosolve - TM / Cellosolve - TM	R	R	—	—	—	—	—	NR
Chloroasetik Asit / Chloroacetic Acid	NR	NR	Q	NR	NR	NR	—	NR
Klor Gaz / Chlorine - Gas	NR	NR	NR	NR	NR	NR	NR	NR
Klor Sıvı / Chlorine - Liquid	R	Q	R	Q	NR	NR	—	NR
Klor Su (% 0,4 Cl) / Chlorine Water (0.4% Cl)	NR	NR	Q	NR	—	—	R	R
Klorobenzen / Chlorobenzene	NR	NR	NR	NR	—	—	Q	—
Kloroform / Chloroform	NR	NR	NR	NR	—	—	NR	NR
Chlorosufonic Asit / Chlorosufonic Acid	R	R	R	Q	—	—	NR	—
Kromik Asit - 50% / Chromic Acid - 50%	R	R	R	R	—	—	—	R
Sitrik Asit / Citric Acid	R	R	R	R	R	—	R	R
Sitrik Asit% 10 / Citric Acid 10%	R	R	R	R	—	—	R	R
Narenciye Suları / Citrus Juices	R	Q	—	—	NR	NR	—	NR
Clorox - TM / Clorox - TM	R	R	R	R	—	—	—	—
Hindistan Cevizi Yağı / Coconut Oil	R	R	R	R	—	—	Q	—
Bakır Bileşikler / Copper Compounds	R	R	R	R	—	—	—	—
Mısır Yağı / Corn Oil	R	R	R	R	—	—	—	—
Pamuk Yağı / Cottonseed Oil	R	R	R	Q	—	—	NR	NR
Kresol / Cresol	R	Q	NR	NR	—	—	—	—
Sikloheksan / Cyclohexane	R	Q	Q	NR	—	—	R	—
Sikloheksanole / Cyclohexanol	R	Q	NR	NR	—	—	R	—
Sikloheksanon / Cyclohexanone	R	R	R	R	R	R	R	—
Deterjanlar / Detergents	R	R	R	R	—	—	—	—
Dekstrin / Dextrin	R	Q	—	—	—	—	R	R
Ftalat Dibütül / Dibutyl Phthalate	NR	NR	NR	NR	Q	Q	R	R
Dietyl Eter / Diethyl Ether	R	R	—	NR	—	—	R	—
Diethylamin / Diethylamine	R	R	R	R	—	—	—	—
Diglycolic Asit -% 30 / Diglycolic Acid - %30	R	R	—	—	—	—	—	—
Diisooctyl Ftalat / Diisooctyl Phthalate	R	R	—	—	—	—	—	—
Ftalat dimetil / Dimethyl Phthalate	R	—	—	—	—	—	R	R
Dimethylamine / Dimethylamine	R	Q	—	—	—	—	R	R

MALZEME UYGUNLUK KODU MATERIAL SUITABILITY CODE

- R = Tavsiye edilir/Recommended**
NR = Tasviye Edilmez/Not Recommended
Q = Kuşku/Questionable
— = Bilgi Mevcut değil/No Available Information

KİMYASALIN ADI CHEMICAL NAME	STANDART MALZEMELER/STANDARD MATERIALS							
	PP		PE		POM		PP Isıya Dayanıklı Heat Resistant	
	(21 °C)	(60 °C)	(21 °C)	(60 °C)	(21 °C)	(60 °C)	(21 °C)	(60 °C)
Diglycolic Asit -% 30 / Diglycolic Acid - %30	R	R	Q	Q	Q	NR	R	R
Diisooctyl Ftalat / Diisooctyl Phthalate	Q	Q	—	—	—	—	—	—
Ftalat dimetil / Dimethyl Phthalate	R	R	—	—	—	—	—	—
Dimethylamine / Dimethylamine	NR	NR	—	—	—	—	—	—
Dioktil Ftalat / Dioctyl Phthalate	R	R	R	R	R	Q	R	Q
Etil Asetat / Ethyl Acetate	R	R	R	R	—	—	Q	—
Etil Eter / Ethyl Ether	R	R	R	Q	—	—	—	—
Ethylamine / Ethylamine	R	Q	R	Q	—	—	NR	NR
Etilen Klorür / Ethylene Chloride	—	—	R	R	Q	Q	—	—
Etilen glikol -% 50 / Ethylene Glycol - %50	R	Q	R	NR	Q	Q	R	R
Ferrik - Demirli Bileşikler / Ferric - Ferrous Compounds	NR	NR	Q	NR	—	—	R	—
Formaldehit -% 37 / Formaldehyde - 37%	Q	NR	R	NR	R	R	R	R
Formik Asit - 85% / Formic Acid - 85%	R	R	R	R	—	—	—	—
Freon / Freon	R	R	—	—	—	—	R	R
Fuel Oil # 2 / Fuel Oil #2	NR	NR	Q	NR	R	R	R	R
Furfural / Furfural	R	Q	NR	NR	—	—	R	R
Benzin / Gasoline	R	R	R	R	—	—	NR	NR
Glikoz / Glucose	R	R	R	R	NR	NR	NR	NR
Gliserin / Glycerol	R	R	R	R	NR	NR	NR	NR
Heptan / Heptane	R	R	R	R	NR	NR	NR	NR
Hekzan / Hexane	R	R	R	R	R	R	Q	Q
Hidrobromik Asit -% 50 / Hydrobromic Acid - 50%	Q	Q	R	Q	—	—	NR	NR
Hidrobromik Asit / Hydrobromic Acid	R	R	R	R	—	—	R	R
Hidroklorik Asit -% 10 / Hydrochloric Acid - 10%	NR	NR	—	—	—	—	—	—
Hidroflorik Asit -% 35 / Hydrofluoric Acid - 35%	R	R	—	—	R	R	—	—
Hidrojen Peroksit -% 3 / Hydrogen Peroxide - 3%	R	R	Q	Q	—	—	—	NR
Hidrojen Peroksit - 90% / Hydrogen Peroxide - 90%	NR	NR	R	—	—	—	R	R
Hidrojen Sülfür / Hydrogen Sulfide	Q	NR	Q	Q	R	R	R	R
Hidroiyodik Asit / Hydroiodic Acid	Q	NR	Q	Q	R	R	R	—
Igepal -% 50 / Igepal - 50%	R	R	R	R	—	—	NR	NR
İyot - Kristaller / Iodine - Crystals	R	Q	R	R	—	—	—	—
İzooktan / Isooctane	—	—	R	R	—	—	—	R
Jet Yakıtı / Jet Fuel	R	R	R	R	—	—	—	—
Gazyağı / Kerosene	R	R	R	R	—	—	R	R
Laktik Asit / Lactic Acid	Q	NR	Q	NR	—	—	—	—
Lanolin / Lanolin	Q	NR	—	—	—	—	—	—
Domuz Yağı / Lard	R	—	—	—	—	—	—	—
Laurik Asit / Lauric Acid	R	R	R	R	R	R	R	R
Kurşun Asetat / Lead Acetate	R	Q	—	—	R	R	R	Q
Limon Yağı / Lemon Oil	R	R	R	R	—	—	Q	—
Ligroin / Ligroin	R	R	R	R	—	—	R	R
Kireç Sülfür / Lime Sulfur	R	—	R	R	—	—	Q	Q
Keten Yağı / Linseed Oil	R	R	R	R	—	—	—	—
Makine Yağı / Lubricating Oil	R	R	R	R	—	—	—	—
Magnezyum Bileşikleri / Magnesium Compounds	R	R	R	R	—	—	R	—
Malik Asit -50% / Malic Acid -50%	R	—	—	—	—	—	—	—
Manganez Sülfat / Manganese Sulfate	NR	NR	—	—	—	—	—	N
Margarin / Margarine	R	Q	NR	NR	—	—	R	—
Civa Bileşikleri / Mercuric Compounds	R	Q	—	—	—	—	—	—
Merkür / Mercury	Q	NR	NR	NR	—	—	Q	Q
Metil Cellosolve / Methyl Cellosolve	R	R	R	R	—	—	—	—
Metil Klorür / Methyl Chloride	Q	NR	R	NR	R	R	—	—
Metil Etil Keton / Methyl Ethyl Ketone	Q	NR	—	—	—	—	R	—
Metil ISOBUTYL Keton / Methyl Isobutyl Ketone	R	R	R	R	—	—	R	R
Metilen Klorür / Methylene Chloride	R	Q	—	—	R	R	R	R
Methylsulfuric Asit / Methylsulfuric Acid	R	Q	Q	NR	—	—	R	R
Madeni Yağ / Mineral Oil	R	R	R	R	—	—	Q	—
Mineral Spirits / Mineral Spirits	R	Q	R	R	NR	NR	NR	NR
Melas / Molasses	Q	NR	R	Q	NR	NR	NR	NR
Motor Yağı / Motor Oil	NR	NR	NR	NR	NR	NR	NR	NR
Naphtta / Naphtta	R	Q	NR	NR	—	—	Q	—
Nikel Bileşikler / Nickel Compounds	Q	NR	—	—	—	—	—	—
Nitrik Asit% 30 / Nitric Acid - 30%	R	—	—	—	—	—	—	—
Nitrik Asit% 50 / Nitric Acid - 50%	R	NR	—	—	R	R	R	R
Nitrik Asit - Tütsülenmiş / Nitric Acid - Fuming	R	R	R	R	—	—	—	—

MALZEME UYGUNLUK KODU MATERIAL SUITABILITY CODE

- R = Tavsiye edilir/Recommended**
NR = Tasviye Edilmez/Not Recommended
Q = Kuşkulu/Questionable
— = Bilgi Mevcut değil/No Available Information

KİMYASALIN ADI CHEMICAL NAME	STANDART MALZEMELER/STANDARD MATERIALS							
	PP		PE		POM		PP Isıya Dayanıklı Heat Resistant	
	(21 °C)	(60 °C)	(21 °C)	(60 °C)	(21 °C)	(60 °C)	(21 °C)	(60 °C)
Zeytinyağı / Olive Oil	R	R	R	R	—	—	Q	—
Oksalik Asit / Oxalic Acid	NR	NR	—	—	—	—	R	R
Oksijen / Oxygen	NR	NR	Q	NR	—	—	Q	Q
Ozon / Ozone	R	R	R	R	—	—	R	R
Palmitik Asit -% 70 / Palmitic Acid - 70%	R	R	—	—	—	—	—	—
Fıstık Yağı / Peanut Oil	R	R	R	R	—	—	—	—
Perklorik Asit -% 20 / Perchloric Acid - 20%	NR	NR	NR	NR	—	—	Q	NR
Perchloroethylene / Perchloroethylene	R	R	R	R	—	—	—	—
PhenolPhthalic Asit -% 50 / PhenolPhthalic Acid - 50%	R	R	R	R	NR	NR	NR	NR
Fenol -% 5 / Phenol - 5%	R	R	R	R	NR	NR	NR	NR
Fosforik Asit% 30 / Phosphoric Acid - 30%	R	R	R	R	—	—	NR	NR
Fosforik Asit% 85 / Phosphoric Acid - 85%	R	R	R	R	—	—	NR	NR
Fotografik Çözümler / Photographic Solutions	R	R	R	R	—	—	R	—
Kaplama Çözümleri / Plating Solutions	R	R	R	R	—	—	—	—
Potasyum Bileşikleri / Potassium Compounds	R	R	R	R	—	—	R	—
Potasyum Hyderoxide / Potassium Hyderoxide	R	R	R	R	—	—	R	—
Potasyum Lodiide (% 3 Lodiide) / Potassium Lodiide (3% Lodiide)	R	R	R	R	—	—	—	—
Potasyum / Potassium	R	Q	R	R	—	—	NR	NR
Permanganat / Permanganate	R	R	—	—	—	—	—	—
Siyanür Gümüş / Silver Cyanide	R	R	R	R	—	—	—	—
Gümüş Nitrat / Siver Nitrate	R	R	R	R	—	—	Q	—
Sodyum Bileşikleri / Sodium Compounds	R	Q	R	R	—	—	Q	NR
Sodyum Klorit / Sodium Chlorite	R	R	R	R	—	—	R	NR
Sodyum Hidroksit / Sodium Hydroxide	R	R	R	R	R	R	R	NR
Sodyum Hidroksit -% 60 / Sodium Hydroxide - 60%	R	Q	—	—	NR	NR	NR	—
Kalaysı Klorür / Stannic Chloride	R	R	R	R	—	—	—	—
Kalay Klorür / Stannous Chloride	R	R	R	R	—	—	—	—
Stearik Asit / Stearic Acid	R	Q	R	R	—	—	R	R
Süksinik Asit / Succinic Acid	R	R	R	R	—	—	—	—
Şeker / Sugar	R	R	R	R	—	—	—	—
Sülfamik Asit -% 20 / Sulfamic Acid - 20%	R	R	—	—	NR	NR	—	—
Sülfat Likörler / Sulfate Liquors	R	R	—	—	—	—	—	—
Kükürt / Sulfur	R	R	R	R	—	—	R	R
Kükürt Klorür / Sulfur Chloride	R	—	—	—	—	—	—	—
Kükürt Dioksit / Sulfur Dioxide	R	R	R	R	—	—	R	Q
Sülfürik Asit -% 3 / Sulfuric Acid - 3%	R	R	R	R	R	R	NR	NR
Sülfürik Asit - 50% / Sulfuric Acid - 50%	R	R	R	R	NR	NR	NR	NR
Sülfürik Asit - 70% / Sulfuric Acid - 70%	R	Q	R	Q	NR	NR	NR	NR
Sülfürik Asit - Tütsülenmiş / Sulfuric Acid - Fuming	NR	NR	NR	NR	NR	NR	NR	NR
Sülfirik Asit / Sulfurous Acid	R	—	R	R	—	—	Q	Q
Donyağı / Tallow	R	R	R	Q	—	—	R	R
Tannik Asit -% 10 / Tannic Acid - 10%	R	R	R	R	—	—	—	—
Tartarik Asit / Tartaric Acid	R	R	R	R	—	—	Q	Q
Tetrahydrofuran / Tetrahydrofuran	Q	NR	—	—	—	—	R	—
Toluene / Tolüen	NR	NR	NR	NR	Q	NR	R	R
Domates Suyu / Tomato Juice	R	R	R	R	—	—	—	—
Trafo Yağı / Transformer Oil	R	Q	R	Q	—	—	R	R
Tributyl Fosfat / Tributyl Phosphate	R	Q	—	—	—	—	—	—
Trikloroasetik Asit / Trichloroacetic Acid	R	R	—	—	—	—	R	NR
Trikloroetilen / Trichloroethylene	NR	NR	NR	NR	—	—	R	NR
Tricresyl Phosphate / Tricresyl Phosphate	R	Q	—	—	—	—	—	—
Trisodyum Phosphate / Trisodium Phosphate	R	R	R	R	—	—	—	—
Terebentin / Turpentine	Q	NR	Q	NR	—	—	R	R
Üre / Urea	R	R	R	R	—	—	R	R
Sirke / Vinegar	R	R	R	R	—	—	—	—
Şarap / Wine	R	R	R	R	—	—	R	R
Ssilen / Xylene	NR	NR	NR	NR	—	—	R	R
Çinko Bileşikleri / Zinc Compounds	R	R	R	R	—	—	Q	—



ÇAĞRI[®]
ENDÜSTRİ A.Ş.

ALHAN

Konveyör ve Parçaları , Mühendislik Plastikleri

ALHAN Hasır Bant Uygulamaları için Teknik Veri Formu

Şirket / Müşteri :

İlgili Kişi :

İletişim Telefon : e-posta :

Teknik Veri:

Endüstri:										
Uygulama:										
Ürün tipi:										
Kapak / konteyner:										
Ürün ölçüleri:	xW:	mm	xL:	mm	xH:	mm				
Ürün ağırlığı:	kg		kg/metre		kg/m. kare					
Konveyör hızı:										
Bant genişliği:	mm									
Bant uzunluğu:	mm									
Bant hatvesi:	mm									
Minimum / maksimum ortam sıcaklığı:		C /		C /						
Kimyasal temas:	<input type="checkbox"/>	Evet, tür:		<input type="checkbox"/>	Hayır					
Konveyör Türü:	<input type="checkbox"/>	Yatay	<input type="checkbox"/>	Dikey	<input type="checkbox"/>	Z Tip	<input type="checkbox"/>	L Tip	<input type="checkbox"/>	Eğimli
	<input type="checkbox"/>	Spiral	<input type="checkbox"/>	Dönüştü						
Bant Rengi :										
Malzeme :	<input type="checkbox"/>	PP	<input type="checkbox"/>	POM						
Pim malzeme:	<input type="checkbox"/>	PP	<input type="checkbox"/>	PA	<input type="checkbox"/>	SS				
Götürücü:	<input type="checkbox"/>	+	<input type="checkbox"/>	-						
Götürücü yüksekliği:	mm		Yan boşluk :	mm	Ara mesafe :	mm				
Dişliçapı / diş sayısı :	mm / Z									
Dişli göbeği:										

Tarih:/...../20.....

İmza

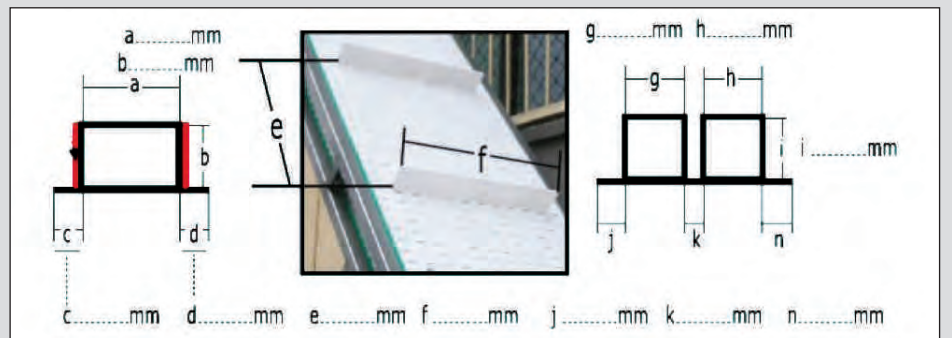

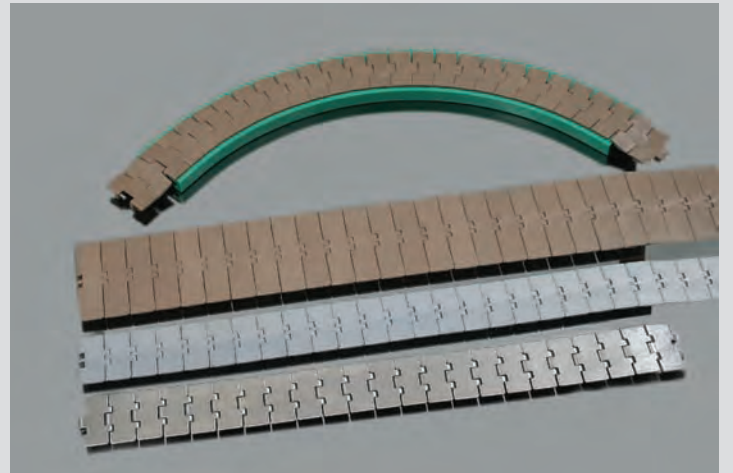
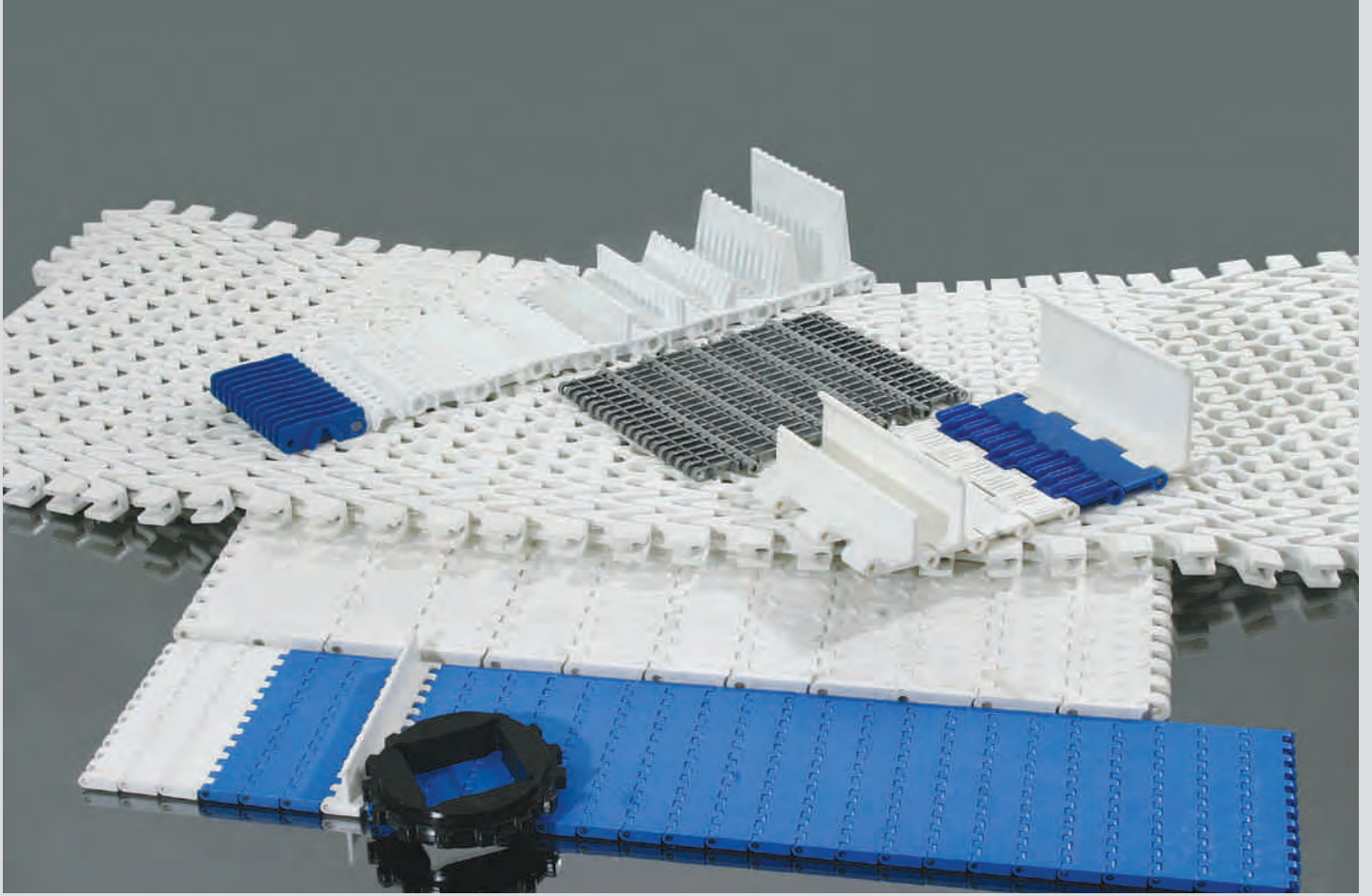



ÇAĞRI[®]
ENDÜSTRİ A.Ş.

ALHAN[®]

Davutpaşa Cad. Nu: 14/1

34010 Topkapı - İSTANBUL - TÜRKİYE

Tel: +90 212 444 00 42 - 544 50 55

Belgegeçer (Fax): +90 212 567 14 16 - 501 54 08

e-posta (e-mail) : info@alhan-cagri.com

www.alhan-cagri.com

+90 532 934 85 02

